

# REVEL

## SPORT



---

# TABLE OF CONTENTS

---

## 1 – INTRODUCTION

About this Manual .....	1-1
Safety Messages Used in this Manual .....	1-1
Pre-Delivery Inspection .....	1-2
Before Driving .....	1-2
Front Axle Tire Alignment .....	1-2
Headlight Alignment .....	1-2
Service and Assistance .....	1-2
Reporting Safety Defects .....	1-3
Occupant and Cargo Carrying Capacity Label .....	1-3
Vehicle Certification Label .....	1-4
Specifications and Capacities .....	1-5
Owner and Vehicle Information .....	1-6

## 2 – SAFETY AND PRECAUTIONS

General Warnings .....	2-1
Driving Safety .....	2-2
Fuel and Propane Gas .....	2-2
Carbon Monoxide Warning .....	2-3
Combination Smoke/Carbon Monoxide Alarm .....	2-4
Fire Extinguisher .....	2-5
Electrical .....	2-5
Loading .....	2-5
Maintenance .....	2-5
Emergency Exits .....	2-6
Power Sofas and Beds .....	2-7
Formaldehyde Information .....	2-7
Mold, Moisture, and Your Motorhome .....	2-7
Roadside Emergency .....	2-8
Wheels .....	2-9
Jump Starting .....	2-9
Engine Overheat .....	2-9

## 3 – DRIVING YOUR MOTORHOME

Seats – Driver/Co-Pilot .....	3-1
Seat Belts .....	3-1
Child Restraints .....	3-2
Keys .....	3-3
Remote Keyless Entry .....	3-3
Hazard Warning Flashers .....	3-3
Air Conditioner/Heater – Automotive (Dash) .....	3-3
Radio – In-Dash .....	3-3

---

## Table Of Contents

---

Engine Cooling System .....	3-3
Diesel Exhaust Fluid Fill .....	3-4
Lights .....	3-4
Tires .....	3-4
Suspension Alignment and Tire Balance .....	3-4

### **4 – APPLIANCES AND SYSTEMS**

Refrigerator .....	4-1
Cooktop (Electric) .....	4-1
OnePlace® Systems Monitor Panel .....	4-2
Solar Charge Panel .....	4-3
Roof Air Conditioning System WITH BLUETOOTH CONTROL .....	4-4
Air Conditioner Filter .....	4-5
Hydronic Heating System .....	4-5

### **5 – ELECTRICAL**

Electrical Cautions .....	5-1
Winnebago x EcoFlow Power Kit Pro Monitor Panel .....	5-1
Power Cord – External (Detachable) .....	5-3
Circuit Breakers – House 120-Volt AC .....	5-4
Electrical Outlets – House 120-Volt AC .....	5-5
Ground Fault Circuit Interrupter .....	5-5
Ecoflow Battery and Chassis Battery Access .....	5-6
Circuit Breakers and Fuses – House 12-Volt DC .....	5-7

### **6 – PLUMBING**

Fresh Water System .....	6-1
Water Pump .....	6-2
Disinfecting Your Fresh Water System .....	6-3
Shower Hose Vacuum Breaker .....	6-5
Exterior Shower/Wash Station .....	6-5
Toilet .....	6-6
Waste Water System – Waste Pump .....	6-7
Waterline and Tank Drain Valves .....	6-8
Winterizing Procedure .....	6-9
Water System Drain Locations .....	6-15

### **7 – FURNITURE AND SOFTGOODS**

Table (Exterior) .....	7-1
Sleeping Facilities .....	7-1
Power Loft Bed .....	7-1
Window Shades/Screens .....	7-4
Sliding door Screen Zipper Enclosure .....	7-4

### **8 – MAINTENANCE AND STORAGE**

Sealants – Inspection and General Information .....	8-1
Roof .....	8-1

---

## Table Of Contents

---

Undercarriage .....	8-1
Exterior Automotive Paint Finish .....	8-2
Exterior Graphic Care .....	8-4
Plastic Parts – Cleaning .....	8-5
Exterior Lights .....	8-5
Interior Soft Goods .....	8-5
Cabinetry – Cleaning .....	8-6
Decorative Vinyl Wall Paneling – Cleaning .....	8-7
Tables and Countertops .....	8-7
Sink – Stainless Steel .....	8-7
Range and Refrigerator .....	8-7
Vinyl Flooring .....	8-7
Bathroom .....	8-8
Windows .....	8-8
Doors and Mirrors .....	8-9
Vehicle Storage – Preparation .....	8-9
Chassis Service and Maintenance .....	8-10
Vehicle Storage – Removal .....	8-10
Motorhome Maintenance Chart .....	8-12

### **9 – MISCELLANEOUS**

Loading the Vehicle .....	9-1
Weighing Your Loaded Vehicle .....	9-1
Car or Trailer Towing .....	9-3
Trailer Wiring Connector .....	9-4
Towing Guidelines .....	9-4
Windows .....	9-5
Power Roof Ventilator (Bath) .....	9-6
Power Roof Ventilator .....	9-6
Awning – Power with bluetooth .....	9-7
Ladder .....	9-8
Tie-Down Rings .....	9-10
Effects of Prolonged Occupancy .....	9-10

---



# SECTION 1 – INTRODUCTION

---

Congratulations! We welcome you to the exciting world of motorhome travel and camping. You will find it convenient and enjoyable to have all the comforts of home and still enjoy the great outdoors wherever you choose to go.

Before sliding into the driver's seat, please become familiar with operations and features. In addition, spend some time with the dealer when you take delivery to learn all you can about your new motorhome.

---

---

## ABOUT THIS MANUAL

This operator's manual was prepared to aid you in the proper care and operation of the vehicle and equipment.

Please read this manual completely to understand how everything in your motorhome works before taking it on its "maiden voyage". In addition, please become familiar with the New Vehicle Limited Warranty.

*NOTE: This manual describes many features of your motorhome and includes instructions for its safe use.*

*This manual, including photographs and illustrations, is of a general nature only.*

***Some equipment and features described or shown in this manual may be optional or unavailable on your model.***

*Because of Winnebago Industries<sup>®</sup>, continuous program of product improvement, it is possible that recent product changes and information may not be included.*

*The instructions included in this manual are intended as a guide, and in no way extend the responsibilities of Winnebago Industries beyond the standard written warranty as presented in this manual.*

*The descriptions, illustrations, and specifications in this manual were correct at the time of printing. We reserve the right to change specifications or*

*design without notice, and without incurring obligation to install the same on products previously manufactured.*

The materials in your InfoCase contain warranty information and operating and maintenance instructions for the various appliances and components in your motorhome.

*NOTE: Many of the instruction sheets and manuals for the various appliances and components have been incorporated into the Operator's Manual Supplement for your convenience.*

*Please read the FAQ in Section 1 of the Operator's Manual Supplement for more details.*

Throughout this manual, frequent references are made to the vehicle chassis manual that is provided by the manufacturer of the chassis on which this motorhome is built.

Consult the chassis manual for operating, safety, and maintenance instructions pertaining to the chassis section of the motorhome.

*NOTE: For some floorplans, Winnebago Industries<sup>®</sup> makes modifications to the chassis, such as extending the wheelbase of the frame. Winnebago's Limited Warranty will apply to any chassis modifications made by Winnebago Industries<sup>®</sup>.*

---

---

## SAFETY MESSAGES USED IN THIS MANUAL

Throughout this manual, certain items are labeled Danger, Warning, Caution, Notice, or Note. These terms alert you to precautions that may involve damage to your vehicle or a risk to your personal safety. Read and follow them carefully.

## SECTION 1 – INTRODUCTION

---



### **DANGER**

DANGER indicates a hazardous situation which, if not avoided, will result in death or serious personal injury.



### **WARNING**

WARNING indicates a hazardous situation which, if not avoided, could result in death or serious personal injury.



### **CAUTION**

CAUTION indicates a hazardous situation which, if not avoided, could result in minor or moderate personal injury.

### **NOTICE**

NOTICE is used to address practices not related to personal injury.

*NOTE: A “Note” is not necessarily safety-related, but indicates a recommendation or special point of information that could assist in understanding the use or care of a feature item.*

---

## **PRE-DELIVERY INSPECTION**

This motorhome has been thoroughly inspected before shipment. Your dealer is responsible for performing a complete pre-delivery inspection of the chassis and all motorhome components.

As a part of the pre-delivery inspection procedure, the dealer is responsible for road testing the motorhome, noting, and correcting any problems before delivery.

---

## **BEFORE DRIVING**

Familiarize yourself with State/Province and local regulations before traveling. There are many local rules that may impact your travels.

---

## **FRONT AXLE TIRE ALIGNMENT**

We recommend that you have the front suspension and steering alignment checked and adjusted after you have fully loaded the vehicle according to your needs. Thereafter, have alignment inspected periodically to maintain vehicle steering performance and prevent uneven tire wear.

---

## **HEADLIGHT ALIGNMENT**

Headlights on this motorhome were aligned at the factory in an unloaded state. We recommend you have the high and low beam alignment checked after fully loading the vehicle to your needs. Thereafter, have the alignment inspected periodically to maintain visibility.

---

## **SERVICE AND ASSISTANCE**

Your dealer will be glad to provide any additional information you need, as well as answer any questions you might have about operating the equipment in your motorhome. When it comes to service, remember that your dealer knows your vehicle best and is interested in your satisfaction. Your dealer will provide quality maintenance and any other assistance that you may require during your ownership of this vehicle.

If you need warranty repairs while traveling, you may take your vehicle to any authorized Winnebago Industries® dealership and request their assistance.

See the Service Dealer Directory in your InfoCase.



# SECTION 1 – INTRODUCTION

---

---

## VEHICLE CERTIFICATION LABEL

This label is affixed to the lower driver side armrest panel, driver door, or the driver side door jamb, depending on model. It contains vehicle identification numbers and other important reference information.

THIS VEHICLE WAS ALTERED BY:					
WINNEBAGO INDUSTRIES, INC.					
IN <sup>1</sup> mm / yyyy AND AS ALTERED IT CONFORMS TO ALL APPLICABLE FEDERAL MOTOR VEHICLE SAFETY STANDARDS AFFECTED BY THE ALTERATION AND IN EFFECT IN mm/yyyy <sup>2</sup>					
SERIAL NO	<sup>3</sup>	VIN	<sup>4</sup>	TYPE	<sup>5</sup> MPV COLOR <sup>6</sup>
XXXX CHAS	15W-XXXX	2017 PASEO		BU848P	168123-A
		<sup>7</sup>		<sup>8</sup>	

### EXPLANATION OF DATA

1. Month and year vehicle was altered at Winnebago Industries®.
2. Month and Year vehicle was completed by the chassis manufacture.
3. Serial Number: This is the serial number assigned to the completed vehicle by Winnebago Industries.
4. Vehicle Identification Number (VIN): This number identifies the chassis on which the motorhome is built. The 10th digit of the VIN designates the chassis model year (J=2018, K=2019, L=2020, etc.). This information is useful when ordering chassis repair parts.
5. Type: States the NHTSA designated usage classification for your motorhome. MPV signifies a Multi-purpose Passenger Vehicle.
6. Color: Signifies the color code number of the decor used throughout the vehicle. This number is necessary for ordering replacement cushions, curtains, carpet, etc.
7. Winnebago® model year and series/family name.
8. Model: Lists the Winnebago product model number of your vehicle.

## **SPECIFICATIONS AND CAPACITIES**

<b>Revel Sport</b>
--------------------

	<b>44C</b>	<b>44N</b>
	<b>Mercedes-Benz® AWD Sprinter Van Chassis</b>	<b>Mercedes-Benz® AWD Sprinter Van Chassis</b>
Feature Number	87E	87E
Length	19' 7"	19' 7"
Exterior Height <sup>1</sup>	10' 0"	10' 0"
Exterior Width	7' 2"	7' 2"
Awning Length	10'	10'
Interior Height	6' 3"	6' 3"
Interior Width	5' 9.75"	5' 9.75"
Freshwater Tank Capacity <sup>2</sup>	24 gal.	24 gal.
Water Heater Capacity	Continuous	Continuous
Cassette Toilet Capacity	5 gal.	5 gal.
Holding Tank Capacity - Gray <sup>2</sup>	21 gal.	21 gal.
Propane Capacity <sup>3</sup>	n/a	n/a
Wheelbase	144"	144"
GVWR	9,050 lbs.	9,050 lbs.
GAWR - Front	4,409 lbs.	4,409 lbs.
GAWR - Rear	5,359 lbs.	5,359 lbs.
GCWR <sup>4</sup>	13,930 lbs.	13,930 lbs.
Fuel Capacity	92 liter (24.5 gal)	92 liter (24.5 gal)

**Notes:**

All information is based upon the most recent data available. Visit the Winnebago Industries, Inc. web page – [www.winnebagoind.com](http://www.winnebagoind.com) – for the most current product information.

<sup>1</sup> The height of each model is measured to the top of the tallest standard feature and is based on the curb weight of a typically equipped unit. The actual height of your vehicle may vary by several inches depending on chassis or equipment variations. Contact your dealer for further information.

<sup>2</sup> Capacities are based on measurements prior to tank installation. Slight capacity variations can result upon installation.

<sup>3</sup> This is a tankless water heating system with continuous capabilities at adjusted flow rates.

<sup>4</sup> Actual towing capacity is dependent on your particular loading and towing circumstances which includes the GVWR, GAWR, and GCWR as well as adequate trailer brakes. Refer to the chassis operator's manual of your motor home for further towing information.

**SECTION 1 –  
INTRODUCTION**

---

---

**OWNER AND VEHICLE INFORMATION**

**OWNER INFO**

Owner's Name(s) \_\_\_\_\_

Address \_\_\_\_\_

\_\_\_\_\_

**VEHICLE INFORMATION**

Motorhome Model Number \_\_\_\_\_

Motorhome Serial Number \_\_\_\_\_

Chassis Vehicle Identification No. (VIN) \_\_\_\_\_

Vehicle Mileage at Delivery \_\_\_\_\_

Selling Dealer Name \_\_\_\_\_

Address \_\_\_\_\_

\_\_\_\_\_

**YOUR WINNEBAGO INDUSTRIES® DEALER /SERVICE CENTER**

Name \_\_\_\_\_

Address \_\_\_\_\_

\_\_\_\_\_

Contact \_\_\_\_\_ Phone \_\_\_\_\_

**CHASSIS SERVICE CENTER**

Name \_\_\_\_\_

Address \_\_\_\_\_

\_\_\_\_\_

Contact \_\_\_\_\_ Phone \_\_\_\_\_

**RV INSURANCE POLICY**

Company \_\_\_\_\_

Policy Number \_\_\_\_\_

Agent \_\_\_\_\_ Phone \_\_\_\_\_

## SECTION 2 – SAFETY AND PRECAUTIONS



---

---

### GENERAL WARNINGS

- Only seats equipped with seat belts are to be occupied while the vehicle is moving.
- Make sure all passengers have seat belts fastened. Lap belts should fit low on the hips and upper thighs. The shoulder belt should be positioned snug over the shoulder.
- For pregnant women: Never place the shoulder belt behind your back or under your arm. Adjust the lap belt across your hips/pelvis, and below your belly. Place the shoulder belt across your chest (between your breasts) and away from your neck.
- Child restraints should be installed properly according to manufacturer's instructions. See "Child Restraints".
- All moveable or swiveling seats should be placed and locked in travel position while the vehicle is moving.
- Never let passengers stand or kneel on seats while the vehicle is moving.
- Sleeping facilities are not to be utilized while vehicle is moving.
- Examine the escape window and be familiar with its operation.
- Inspect the fire extinguisher monthly for proper charge and operating condition. This should also be done before beginning a vacation or any extended trip.



### WARNING

Operating, servicing and maintaining this vehicle can expose you to chemicals including engine exhaust, carbon monoxide, phthalates, and lead, which are known to the State of California to cause cancer and birth defects or other reproductive harm. To minimize exposure, avoid breathing exhaust, do not idle the engine except as necessary, service your vehicle in a well-ventilated area and wear gloves or wash your hands frequently when servicing your vehicle. For more information go to [www.P65Warnings.ca.gov/passenger-vehicle](http://www.P65Warnings.ca.gov/passenger-vehicle).



## SECTION 2 – SAFETY AND PRECAUTIONS

---

---

### DRIVING SAFETY



#### WARNING

This motorhome has been designed, manufactured and tested with concern for the protection of its occupants. We recommend you perform the following inspections for your safety and the safety of your passengers before starting your vehicle.

1. **WHEELS** - Inspect for damage and check lug nuts for tightness.
2. **TIRES** - Inspect for wear and damage and check for recommended air pressure.
3. **LIGHTING** - Test for proper operation of all interior and exterior lights including dash lights, headlights, tail lights, brake lights, clearance lights, and turn signals.
4. **EXITS** - Inspect release mechanism on emergency exit window, test both locks on main entrance door for ease of operation and instruct passengers how to use both means of exit.
5. **SEAT BELTS** - Direct passengers to designated seats, be certain swivel seats are locked into position, and require use of a seat belt. See operator's manual for occupancy and weight restrictions.
6. **APPLIANCES** - Turn off and latch or lock doors where provided.
7. **LOOSE PARCELS** - Store securely.
8. **UTILITY SUPPLY LINES** - Disconnect all electrical, sewer and water lines and secure properly.
9. **ENTRANCE DOOR STEP** - Assure step is in retracted position for traveling.

Read your motorhome and chassis owner's manual for further precautions.

- Use care when accelerating or decelerating on a slippery surface. Abrupt speed changes can cause skidding and loss of control.
- Never drive the vehicle with a slideout room extended.
- Driving through water deep enough to wet the brakes may affect stopping distance or cause the vehicle to pull to one side. Check brake operation in a safe area to be sure they have not been affected. Never operate any vehicle if a difference in braking efficiency is noticeable.
- Adverse weather conditions and extremes in terrain may affect handling and/or performance of your vehicle. Refer to your chassis manual for complete and related information on driving your vehicle.
- Doors - Verify all interior and exterior doors are shut and/or stowed and latches are in place where provided.

---

---

### FUEL AND PROPANE GAS



#### WARNING

Do not fill propane container(s) to more than 80 percent of capacity. A properly filled container contains approximately 80 percent of its volume as liquid propane. Overfilling propane container(s) can result in uncontrolled propane flow, which could lead to a fire or explosion and result in death or serious injury.

- Do not attempt to adjust the driver's seat while the vehicle is moving.
- Do not adjust tilt steering in a moving vehicle.
- Do not operate the cruise control on icy or extremely wet roads, winding roads, in heavy traffic, or in any other traffic situation where a constant speed cannot be maintained.



 **WARNING**

Do not place propane cylinders inside the vehicle.  
Propane cylinders are equipped with safety devices that relieve excessive pressure by discharging propane to the atmosphere.  
Propane gas is highly flammable.  
Can lead to a fire or explosion and result in death or serious injury.

- Do not place or store gasoline or other flammable liquid containers inside the vehicle.
- Never smoke while refilling vehicle fuel tank or propane gas tank.
- Portable fuel-burning equipment, including wood and charcoal grills and stoves shall not be used inside the recreational vehicle. The use of this equipment inside the recreational vehicle may cause fires or asphyxiation.
- Propane gas regulators must always be installed with the diaphragm vent facing downward. Regulators are equipped with a protective cover. Make sure that the regulator vent faces downward and that the cover is kept in place to minimize vent blockage, which could result in excessive gas pressure causing fire or explosion.

 **DANGER**

Do not use gas cooking appliances for comfort heating. Can lead to carbon monoxide poisoning, which can lead to death or serious injury.

 **WARNING**

Gas cooking appliances need fresh air for safe operation.  
Before operating:  
Open vents or windows slightly or turn on exhaust fan prior to using cooking appliance. Gas flames consume oxygen, which should be replaced to ensure proper combustion. Improper use can result in death or serious injury.

Unlike homes, the amount of oxygen supply is limited due to the size of the recreational vehicle, and proper ventilation if you bring in a gas fired cooking appliance(s) avoids dangers of asphyxiation. It is especially important that cooking appliances not be used for comfort heating, as the danger of asphyxiation is greater when the appliance is used for long periods of time. Failure to comply could result in death or serious injury.

---

---

**CARBON MONOXIDE  
WARNING**

 **WARNING**

Avoid inhaling exhaust gases, as they contain carbon monoxide, which is a colorless, odorless, and poisonous gas. Death or serious injury can result.

The best protection against carbon monoxide entry into the vehicle body is a properly maintained engine exhaust and ventilation system. It is recommended that the exhaust system and body be inspected by a qualified motorhome service center:

- Each time the vehicle is serviced for an oil change.
- Whenever a change in the sound of the exhaust system is noticed.



## SECTION 2 – SAFETY AND PRECAUTIONS

- Whenever the exhaust system, underbody, or rear of the vehicle is damaged.

To allow proper operation of the vehicle’s ventilation system, keep front ventilation inlet grill clear of snow, leaves, or other obstructions at all times. **DO NOT OCCUPY A PARKED VEHICLE WITH ENGINE RUNNING FOR AN EXTENDED PERIOD.**

Do not run engine in confined areas, such as a garage, except to move vehicle into or out of the area.

---



---

### **COMBINATION SMOKE/ CARBON MONOXIDE ALARM**

Your motorhome is equipped with a smoke and carbon monoxide alarm (located on the ceiling in the lounge area.) The alarm is powered by a 9-volt battery and has 2 separate alarms. The CO sensor can detect carbon monoxide gas from any source, and will not detect any other form of gases. Carbon monoxide gas is only registered at the sensor, carbon monoxide gas may be present in other areas. It will detect CO gas from any combustion source such as the furnace, gas range/oven, water heater, refrigerator, chassis engine, and electric generator engine.

The smoke alarm will not detect heat, gas or flames, and will only detect smoke that reaches the sensor. To reduce the risk of carbon monoxide poisoning, test this alarms operation after the motorhome has been in storage, before each trip, and at least once per week during use by pressing the Test/Reset button on the alarm.



Smoke/carbon monoxide alarm.  
-Typical View

The following label is affixed to the smoke alarm.

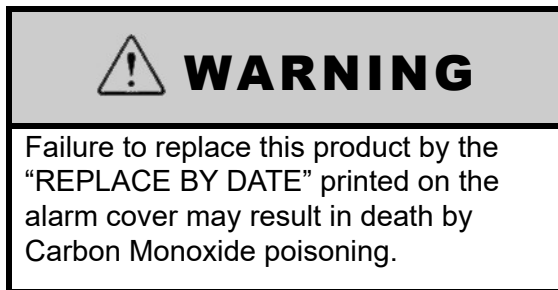
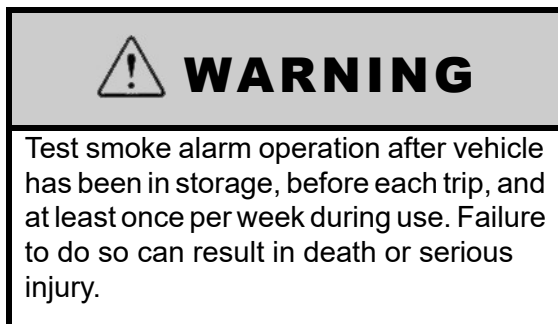

### **Replacement**

When replacing this alarm, we recommend replacing only with the same model, or with one that is also listed for RV application. We recommend obtaining a replacement from your Winnebago Industries® dealer.

### **Expiration and Further Information**

See the manufacturer’s information in your Info-Case for smoke alarm expiration and further instructions.



---

---

## **FIRE EXTINGUISHER**

A dry chemical Fire Extinguisher is located near the sliding entrance door.

We recommend that you become thoroughly familiar with the operating instructions displayed on the side of the Fire Extinguisher and in the information supplied in your InfoCase.

We also recommend that you inspect the Fire Extinguisher for proper charge at least once a month in accordance with National Fire Protection Association (NFPA) recommendations as stated on the label.

If the extinguisher is past its expiration date or charge is insufficient, the Fire Extinguisher must be replaced.

### **NOTICE**

Do not test the fire extinguisher by discharging it. Partial discharge can cause leakage of pressure or contents, which would render the unit inoperative when needed. When using the fire extinguisher, aim the spray at the base of the fire.

## **Replacement**

If for any reason you must replace the Fire Extinguisher, the replacement must be the same type and size as the one originally supplied in your motorhome. We recommend obtaining a replacement only from your Winnebago Industries® dealer or a reliable RV parts supplier.

---

---

## **ELECTRICAL**

- Careless handling of electrical components can be fatal. Never touch or use electrical components or appliances while feet are bare, while hands are wet, or while standing in water or on wet ground.

- Improper grounding of the vehicle can cause personal injury. Do not plug the utility power cord into an outlet which is not grounded and do not adapt the plug to connect to a receptacle for which it is not designed.
- Do not attach an extension cord to the utility power cord.
- Do not use any electrical device that has had the ground pin removed.
- Avoid overloading electrical circuits. Replace fuses or circuit breakers with those of the same size and amperage rating only. Never use a higher rated fuse or breaker.
- Use caution when handling or working near electrical storage batteries. Always remove jewelry and wear protective clothing and eye covering. Avoid creating sparks.

---

---

## **LOADING**

- Store or secure all loose items inside the motorhome before traveling. Possible overlooked items such as canned goods or small appliances on the countertop, cooking pans on the range, or free-standing furniture items can become dangerous projectiles during a sudden stop.
- Be aware of GVWR, GAWR, and individual load limit on each tire or set of duals (See “Loading the Vehicle” in *Section 11 - Miscellaneous*).
- Never load the motorhome in excess of the gross vehicle weight rating or the gross axle weight rating for either axle.

---

---

## **MAINTENANCE**

- Do not remove the radiator cap while engine and radiator are still hot. Always check coolant level visually at the see-through coolant reservoir.
- Never get beneath a vehicle that is held up by a leveling system (if equipped), or a jack only.
- Always release the air prior to getting under the vehicle (if equipped).



## SECTION 2 – SAFETY AND PRECAUTIONS

- Do not mix different construction types of tires on the vehicle, such as radial, bias, or belted tires, as vehicle handling may be affected. Replace tires with exact size, type, and load range.
- Refer to the chassis manual for complete maintenance precautions and recommendations.

---

---

## EMERGENCY EXITS

### Sliding Door

1. Unlock the sliding door by pulling up on the unlock lever.



2. To open the passenger side sliding door, push down on the release button on the left-hand side of the door while pushing door outward and sliding to the right.



### Rear Double Doors

1. Unlock the rear passenger side double door by sliding latch to the left. You will see an unlock icon.



2. On passenger side door, pull latch forward and push door open.



*NOTE: The rear passenger side door must be open before opening the rear driver side door.*

3. On driver side door, push latch rearward and push door open.



---

---

## **POWER SOFAS AND BEDS**



### **WARNING**

Keep people away from operating mechanism and pinch hazard areas during use. Failure to do so could cause injury.

---

---

## **FORMALDEHYDE INFORMATION**

Some of the materials used in this recreational vehicle emit formaldehyde. Eye, nose, and throat irritation, headache, nausea, and a variety of asthma-like symptoms, including shortness of breath have been reported as a result of formaldehyde exposure. Reaction to formaldehyde exposure may vary among individuals. Elderly persons and young children, as well as anyone with a history of asthma, allergies, or lung problems may be at greater risk. Research is continuing on the possible long-term effects of exposure to formaldehyde. Inadequate ventilation may allow formaldehyde and other contaminants to accumulate in indoor air. Ventilation to dilute the indoor air may be obtained from a passive or mechanical ventilation system. Always be sure to thoroughly ventilate your recreational vehicle before and during each use. High indoor temperatures and

humidity may raise formaldehyde levels. When a recreational vehicle is in areas subject to high temperatures, an air conditioning system can be used to control indoor temperature levels. If you have any questions regarding the health effects of formaldehyde, consult your doctor or local health department.

---

---

## **MOLD, MOISTURE, AND YOUR MOTORHOME**

### **What is Mold?**

Molds are part of the natural environment. They are as old as the Earth itself and mold spores are almost everywhere at some level waiting to grow. Mold plays a part of nature by breaking down dead organic matter, such as fallen leaves and dead trees. Indoors however, mold growth should be avoided. Molds reproduce by means of tiny spores. Those spores are invisible to the naked eye and float throughout the outdoor and indoor air. Because of the nature of the use of a motorhome, it is natural for a motorhome to be introduced into an environment with mold spores.

Mold is a plant and requires its own special environment to grow. That environment includes organic materials, nutrients, moisture, and proper temperature.

### **How Can I Avoid Mold?**

To reduce the ability for mold to grow, you must reduce what constitutes its growth environment. Mold can grow with the smallest of a nutrient base. Just small amounts of dirt or dust on the carpet can be enough to allow the mold process to begin. Keep the environment as clean as possible. Vacuum the carpet. Clean food spills thoroughly and quickly. Avoid grease buildup near the stove or sink. Clean the exhaust fan above the stove often.

Minimize moisture in your motorhome and keep humidity low. Clean spills quickly. Do not allow condensation to build up. You can open windows and vents to minimize condensation.



## SECTION 2 – SAFETY AND PRECAUTIONS

---

Use of the air conditioner can assist in removing moisture from the air. Avoid leaks, but if leaks do occur, make repairs promptly.

Avoid bringing mold into your motorhome. Plants, cloths, books, and other household items may already have mold present. It is easy to transfer mold into your motorhome environment.

Monitor your motorhome. Periodically check those hidden areas in corners, closets, and cabinets to assure mold is not present.

### What if I Find Mold?

If mold develops, clean the area with a concentrate of soap and bleach. Items that contain mold that cannot be cleaned should be removed from the vehicle.

### Can Mold Harm Me?

The effects of mold and airborne mold spores may cause irritation to some people. Experts disagree on the level of exposure that may cause health concerns.

### If Mold Is Present, What Will Winnebago Industries® Do?

If Winnebago Industries determines that mold is present in the motorhome as a result of a manufacturing defect reported to Winnebago Industries within the limited warranty period, Winnebago will clean the affected area(s) and/or replace affected items as it deems necessary. This is the extent of coverage provided by Winnebago Industries. Winnebago Industries, however, will not assume responsibility for mold deemed to be a result of a motorhome users lack of timely and appropriate action to mitigate circumstances should a problem occur.

If Winnebago Industries determines that mold is present due to conditions it determines is not a result of a manufacturing defect found within the warranty period, Winnebago Industries will not provide any financial assistance to the repair of the condition.

---

---

## ROADSIDE EMERGENCY

Because of the size and weight of this vehicle and its tires, and the possible complications involved in tire changing, we strongly advise obtaining professional road service to change a flat tire whenever possible. However, if an emergency requires you to change the tire yourself, please exercise extreme caution and read all tire changing information in the chassis manual.

Never get beneath a vehicle that is held up by a jack only.

### If You Get A Flat Tire

- DO NOT panic.
- Grip the steering wheel firmly and steer the vehicle as straight as possible. Avoid quick maneuvers. You may need to counter-steer to compensate for “pull” created by the failed tire.
- DO NOT stomp on the brake. This abruptly shifts the vehicle’s weight forward, making it nose-dive and pull toward the blown-out side.
- DO NOT jerk your foot off the accelerator. Just ease back on the accelerator slowly and gently to continue momentum. The deflated tire will slow the vehicle.
- If you must change lanes to get to a safe stopping place, use your signals to warn other motorists and change lanes smoothly and carefully after you are certain the lane is clear.
- Let the vehicle coast to a stop, gently steering to a safe stopping place off the traffic lanes of the road. Do not worry about damaging the tire or wheel rim by driving on it. A tire or wheel replacement is cheaper than damaging the vehicle or injuring yourself.
- When you have come to a stop, activate your hazard flashers to warn other motorists, then exit the vehicle carefully.
- Set out flares or other warning devices.

Check your tires for proper inflation before each trip and at least once a month with an accurate tire gauge. See “Valve Stem Access” in *Section 3 - Driving Your Motorhome*.



## Spare Tire Storage

If your motorhome is supplied with a spare tire, it is located on a swing-down spare tire carrier beneath the rear of the motorhome.

Please follow all safety warnings and instructions for removing spare tire from the carrier.

### **CAUTION**

Do not lie beneath tire carrier while removing tire. The tire can fall and injury can occur.

## Recovery Towing

When calling a professional towing service, we recommend that you advise them of your motorhome length and approximate front axle weight listed on your Vehicle Certification Label. This will allow the towing operator to determine the proper towing equipment to use.

Winnebago Industries® does not assume responsibility for damage incurred while towing this vehicle.

*NOTE: Consult your chassis manual for towing instructions or precautions provided by the chassis manufacturer.*

### **NOTICE**

Do not lift on bumper. Damage will result to front end body parts.

### **WARNING**

Stay out from beneath the motorhome while it is suspended by the towing assembly. Do not allow passengers to occupy a towed vehicle. Death or serious injury can result.

## WHEELS

Please see the chassis manual for specific tire information and safety.



Never operate the vehicle with less than 6 lug bolts installed and properly torqued.  
-Typical View

### **WARNING**

DO NOT operate the vehicle with less than all 6 lug bolts installed and properly torqued.

## JUMP STARTING

To jump start the engine using another vehicle or booster system, see the chassis manual for connecting jumper cables to the automotive electrical system.

### **NOTICE**

Do not attempt to push start this vehicle. Damage to the transmission or other parts of the vehicle will occur.

## ENGINE OVERHEAT

If you see or hear steam escaping from the engine compartment or have any other reason to suspect an extreme engine overheating condition,



## SECTION 2 – SAFETY AND PRECAUTIONS

---

pull the vehicle over to the roadside as soon as it is safe to do so, stop the engine, and get all passengers out of the vehicle.

### **NOTICE**

Operating a vehicle under a severe overheating condition can result in damage to the vehicle.

For information on what to do in case of overheating, consult the chassis manual.

## SECTION 3 – DRIVING YOUR MOTORHOME

---

The information in this section refers only to features installed or adapted to the dash and driver compartment area by Winnebago Industries®. It also includes passenger seating in the living area of the motorhome.

### Further Information

See the chassis manual in your InfoCase for all original chassis related controls, instrumentation, switches, and other features. This includes items such as cruise control, climate controls, gauges, wipers, lights, front seats, and three-point safety belts, etc.

---

### SEATS – DRIVER/CO-PILOT

The driver and co-pilot seats may be independently adjusted to suit individual preference.

 <b>WARNING</b>
Damage to interior door panels will result if seats are swiveled toward the doors. Do not turn driver seat counter clockwise and do not turn passenger seat clockwise.

### Further Information

See the chassis manual in your InfoCase for instructions on seat adjustments.

---

### SEAT BELTS

Seats intended for occupancy while the vehicle is in motion are equipped with seat belts for the protection of the driver and passengers.

#### Lap Belts

The lap belts must be worn as low as possible and fit snugly across the hip area. Always sit erect and well back into the seat. To gain full protection of the safety belt, never let more than one person use the same safety belt at any one

time, and do not let the safety belts become damaged by pinching them in the doors or in the seat mechanism. After any serious accident, any seat belts which were in use at the time must be inspected and replaced if necessary.

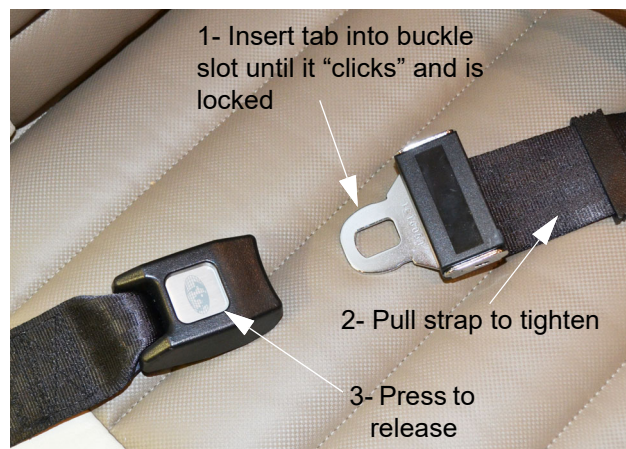

#### Adjustment

To lengthen belt, swivel the tab end at a right angle to belt and pull strap to desired length. To shorten, pull loose end of belt.

#### To Fasten

Be sure belt is not twisted. Grasp each part of the belt assembly and push tongue into buckle. Adjust to a snug fit by pulling the loose end away from the tongue.

#### To Release

Press button in center of buckle and slide tongue out of buckle.

## SECTION 3 – DRIVING YOUR MOTORHOME

---



### **WARNING**

Snug and low belt positions are essential. This will ensure that the force exerted by the lap belt in a collision is spread over the strong hip area and not across the abdomen, which could result in serious injury.

Only seats equipped with seat belts are to be occupied while vehicle is in motion. Swivel seats must be in the locked, forward facing position while vehicle is in motion.

### **Lap/Shoulder Belts**

#### **Fastening**

Hold the belt just behind the tongue. Next, bring the belt across the body and insert the tongue into the buckle until the latch engages.

#### **Unfastening**

Press the release button in the buckle. Hold onto the tongue when you release it from the buckle to keep it from retracting too rapidly.

When the lap-shoulder belt is in use, the lap belt must ride low across the hip area and the shoulder belt must ride diagonally over the shoulder toward the buckle.

The shoulder belt is designed to lock only during a sudden stop, sudden body movement, or a collision. At all other times it will move freely with the occupant.



### **WARNING**

Never wear the shoulder belt in any position other than as stated above. Failure to do so could increase the chance or extent of injury in a collision.

### **Seat Belt Care and Cleaning**

- Be careful not to damage the belt webbing and hardware. Take care not to pinch them in the seat or doors.

- Inspect the belts and hardware periodically. Check for cuts, frays, and loose parts. Damaged parts should be replaced. Do not remove or modify the belt system.
- Keep belts clean and dry. If the belts need cleaning, use only a mild soap and water solution. Do not use hot water. Do not use abrasive cleaners, bleach, or dyes. These products may weaken the belts.
- Replace any belt assembly that was used during a severe impact. Replace the complete assembly even if damage is not apparent.

---

### **CHILD RESTRAINTS**

A properly installed and secured child restraint system can help reduce the chance or severity of personal injury to a child in an accident or during a sudden maneuver. Children may have a greater chance of being injured in an accident if they are seated in a child restraint system which is not properly secured. Children are always safer in the rear seats (behind the cab seats).

A child restraint system is designed to be secured in a vehicle seat by a lap belt or the lap belt portion of a lap-shoulder belt.

When purchasing a child restraint system, follow these guidelines:

1. Look for the label certifying that it meets all applicable safety standards.
2. Make sure that it will attach to your vehicle and restrain your child securely and conveniently so that you are able to install it correctly each time it is used.
3. Be certain that it is appropriate for the child's height, weight, and development. The instructions and/or the regulation label attached to the restraint typically provides this information.
4. Review the instructions for installation and use of the restraint. Be sure that you understand them fully and can install the restraint properly and safely in your vehicle.

---

---

## **KEYS**

Your motorhome is supplied with several keys. In addition to the chassis manufacturer's ignition key, you receive keys for the entrance door and exterior compartment doors.

Keys have an identification number, either a small metal tag or stamped into the key head. These numbers are recorded on the vehicle's component model/serial sheet, which is included in your InfoCase. In case keys are lost or stolen, your dealer or a locksmith can provide you with duplicate keys or modify the locks.

---

---

## **REMOTE KEYLESS ENTRY**

The entry and cab doors on your vehicle are featured with a chassis-supplied Remote Keyless Entry system, which you can lock and unlock these doors using the provided keyless remote transmitter.

Make a habit of having the keys with you when you exit the vehicle and if opening the cab door first before opening the entry door whenever unlocking with the keyless remote.

*NOTE: If a cab door is not opened within 40 seconds of unlocking, the doors will re-lock automatically.*

### **Further Information**

Refer to the chassis manual provided in your InfoCase for complete operating instructions on using the Remote Keyless Entry system and for battery replacement information.

---

---

## **HAZARD WARNING FLASHERS**

The hazard warning flashers provide additional safety when the vehicle must be stopped on the side of the roadway and presents a possible hazard to other motorists. When the flashers are on, it serves as a warning to other drivers.

### **Further Information**

Refer to the chassis manual provided in your InfoCase for instructions on activating, operating, and canceling hazard warning flashers.

---

---

## **AIR CONDITIONER/HEATER – AUTOMOTIVE (DASH)**

See the chassis manual for operating information on driver and passenger comfort controls – air conditioner, heater, defroster, and ventilation.

*NOTE: The dash air conditioner is not designed to cool the entire interior of the motorhome, but is intended only to provide cooling for the cab area.*

---

---

## **RADIO – IN-DASH**

### **–If Equipped**

The radio in your motorhome may be chassis-supplied. Refer to the chassis manual for complete features, programming, and operating instructions.

---

---

## **ENGINE COOLING SYSTEM**

Do not remove the radiator cap while engine and radiator are still hot. Always check coolant level visually at the see-through coolant reservoir.

*NOTE: Your chassis engine cooling system is filled with special extended-life coolant. See the chassis manual for the correct type of coolant. The coolant system MUST be refilled or topped up with the same type of coolant as equipped to maintain the special long-life properties.*

### **Further Information**

Refer to the chassis manual in your InfoCase for information and precautions on filling, servicing, and checking the fluid level.

## SECTION 3 – DRIVING YOUR MOTORHOME

---

---

---

### DIESEL EXHAUST FLUID FILL

The Diesel Exhaust Fluid Fill is located under the front hood.

*NOTE: Use only certified diesel exhaust fluid (DEF) in the Diesel Exhaust Fluid Fill tank.*



Diesel Exhaust Fluid Fill  
(Located under front hood)  
-Typical installation shown

### Further Information

Refer to the chassis manual provided in your InfoCase for complete information and precautions.

---

---

### LIGHTS

All exterior lights should be checked for proper operation each time the vehicle is prepared for a trip. Any bulbs which fail to light should be checked and replaced, when necessary, with a new bulb of the same size. A failure of more than one light, such as both taillights not operating, may indicate a burned out fuse. Check fuse and replace with one of the same rating when necessary. If a fuse is not the cause of the problem, the wiring system should be checked immediately by an authorized service center.

### Further Information

Refer to the chassis manual in your InfoCase for further information.

---

---

### TIRES

Improper tire pressure can result in tire overloading and abnormal wear and also affects handling, ride characteristics, and fuel economy.



### WARNING

Make sure all replacement tires are of the same size and rating as those shown on your Vehicle Certification Label.

---

---

### SUSPENSION ALIGNMENT AND TIRE BALANCE

The front suspension and steering system of this vehicle was factory aligned using highly accurate equipment prior to delivery to the dealership. However, alignment should be checked and adjusted after you have fully loaded the motorhome according to your personal needs. Thereafter, the alignment should be periodically inspected to help prevent uneven tire wear.

Any excessive or abnormal tire wear may indicate worn or misaligned suspension or steering, unbalanced tire, or other tire/suspension problem.

Alignment can be affected by worn steering/suspension parts or by incidents which happen during driving, such as hitting a curb, pothole, or railroad track, etc. Improper alignment can cause tires to roll at an angle and wear unevenly. It may also cause the vehicle to “pull” to the right or left. Have your dealer inspect your vehicle’s suspension and steering components periodically for misalignment or wear.

Out-of-balance tires will not roll smoothly and can lead to vibrations and uneven tread wear, such as cupping and flat spots. Tires may need to be balanced if uneven wear is detected or if ride comfort decreases noticeably.

**Further Information**

Refer to the chassis manual provided in your InfoCase for further information.



# SECTION 4 – APPLIANCES AND SYSTEMS

The appliances installed in your motorhome are manufactured by reputable RV appliance makers and have been tested by independent laboratories to meet all applicable standards and codes set for RV appliances.

See *Section 2 - Safety and Precautions* of this manual for any safety and precautions you need to take regarding the operation of your appliances.

---

---

## REFRIGERATOR

The refrigerator in your coach operates from 12-Volt DC Electric. The unit will always run on 12-Volt when 12-Volt is available. When the lithium batteries are ON and the DC output is enabled on the EcoFlow touchscreen the refrigerator will have 12 volt power.

The 12-Volt Converter will power the refrigerator when connected to 110-Volt power.



### WARNING

Do not let children play inside the motorhome unattended. Unlike your home refrigerator/freezer that one could push open the door from the inside, your motorhome refrigerator has a travel latch and when engaged would trap a child inside resulting in suffocation leading to death or serious injury.

### Basic Operation

- Turn the power on and set the thermostat between 3 and 4. Allow the refrigerator to cool down to temperature before placing food inside.

*NOTE: The refrigerator will retain temperature more efficiently if food is cold before placing inside.*

- To turn off the refrigerator, turn the thermostat counterclockwise past the click.

### Further Information

Refer to the manufacturer's user guide provided in your InfoCase for complete operating instructions, safety precautions, and maintenance information.

---

---

## COOKTOP (ELECTRIC)

### -If Equipped

The cooktop in your motorhome operates on electricity and will provide most of the functions of the range in your home.

The cooktop is stored in the drawer in the counter-top. **DO NOT use the stove while it is in the drawer.**

To operate, remove the stove from the drawer and plug into 20 AMP GFI Outlet. We conveniently provide a 20 AMP GFI outlet for use on the counter-top, and a 20 AMP receptacle near the floor for use with the exterior table. Ensure that the stove is cooled down completely before you place it back into storage.

Refer to the appliance manufacturer's user guide provided in your InfoCase for complete cooktop features and operating instructions.



The cooktop is located in the drawer below in the counter-top- remove from drawer before use.

-Typical View

## SECTION 4 – APPLIANCES AND SYSTEMS

*NOTE: When operating the cooktop on Inverter power, it is recommended to use power setting “7” or lower. This will maximize battery run time and avoid potential error codes on the inverter panel.*

*NOTE: See the appliance manufacturer’s user guide provided in your InfoCase for complete operating instructions and safety precautions.*

### Avoiding Asphyxiation

Unlike homes, the amount of oxygen supply is limited due to the size of the recreational vehicle, and proper ventilation when using the cooking appliances avoids dangers of asphyxiation.

It is especially important that cooking appliances not be used for comfort heating, as the danger of asphyxiation is greater when the appliance is used for long periods of time.

 **WARNING**

Portable fuel-burning equipment including wood and charcoal grills and stoves, shall not be used inside the recreational vehicle. The use of this equipment inside the recreational vehicle can cause fires or asphyxiation. Failure to comply could result in death or serious injury.

### Water And Holding Tank Levels

Press the Tank Levels switch to show approximate levels on the LCD screen.

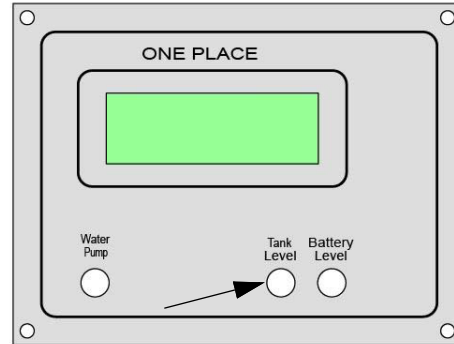

Tank Levels Switch

The approximate fluid levels are measured by electronic sensors on the sides of the tanks. Tank levels are displayed as 1/3, 2/3, and Full (F). There is generally more fluid in a tank than indicated on the monitor panel.

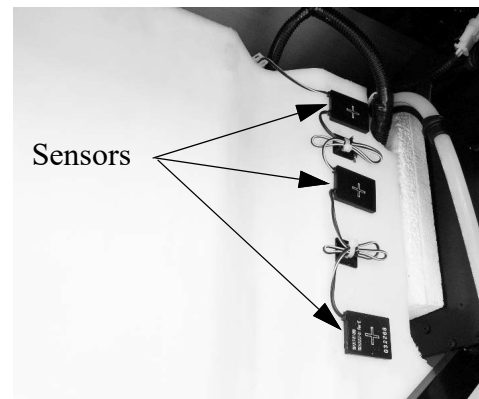

Water Tank  
-Typical View

---

### ONEPLACE® SYSTEMS MONITOR PANEL

The OnePlace Systems Monitor Panel provides a convenient, central location for checking the condition of all utility systems in your coach.

At the touch of a button, the monitor panel will display the fresh water and holding tank levels, plus the chassis battery and house battery condition.

### Tank Capacities

See “Tank Capacities” in *Section 1 - Introduction*.

### Battery Charge Meter

Press the Battery Levels switch to check the level of charge (voltage) in the chassis and house batteries.

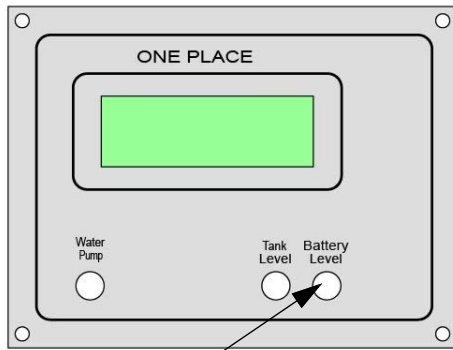

**Battery Levels Switch**

To get an accurate reading:

- Both the chassis engine and the generator engine must be shut off and 120-volt AC shoreline unplugged.
- An interior light should be turned on to provide a small load which draws off the battery surface charge.

### **Water Pump Switch**

Press the Pump switch to activate or deactivate. Water will be available as soon as a faucet is opened.

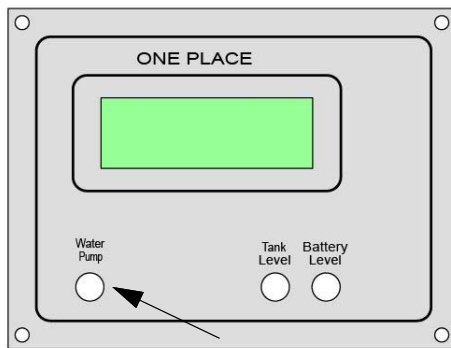

**Water Pump Switch**

Refer to *Section 6 - Plumbing* for additional information on the water pump and initial start-up.

## **SOLAR CHARGE PANEL**

### **-If Equipped**

The roof-mounted Solar Charge Panel uses the sun to help keep your house batteries charged, and is actively charging the house batteries. The controls and monitoring of the solar charge panel is located within the EcoFlow monitor panel

The solar charging system installed in your motorhome has a maximum input rating of 510 Watts. Every solar panel connected to the system needs to be accounted for, this includes all roof mounted panels and the ground level single solar port.



**Solar Charge Controller operated through EcoFlow panel.  
(Located on the monitor panel).  
-Typical View**

### **2-Port Solar Cap**

The Port Solar Cap (located on the roof) is intended to make it easy to add additional solar panels to the roof. The 2 -Port Solar Cap when fully loaded has a maximum input rating of 450 Watts.

## SECTION 4 – APPLIANCES AND SYSTEMS

---

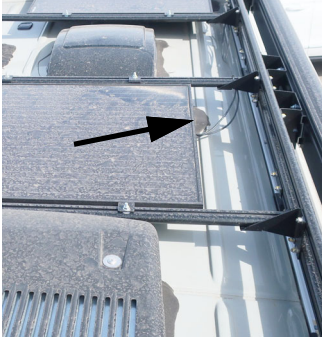

2-Port Solar Cap  
(Located on the roof underneath solar panel).  
-Typical View

### Single Solar Port –If Equipped

The Single Solar Port (located at ground level) is for using a portable solar panel, it has a maximum input rating of 150 Watts. The Single Solar Port is connected to the coach batteries through the solar charge controller (located inside rear driver side exterior compartment). When connecting a portable solar panel, a separate solar charge controller is not needed and will reduce the effectiveness of the portable solar panel.



Single Solar Port  
(Located behind driver's side rear door.)  
-Typical View

*NOTE: The Solar Charge Panel is not intended to make the coach battery system "maintenance free." The solar panel will not completely compensate for*

*continuous low amperage draw from components such as the propane gas leak detector (if equipped), the dash radio clock, and the radio station memory circuitry, for example.*

*Although the Solar Charge Panel can help to extend battery life, the motorhome shoreline should be plugged in routinely to "top off" the batteries. We also recommend following regular battery inspection and maintenance, especially in cold weather. See "Battery Care" in Section 6 - Electrical.*

### Further Information

Refer to the manufacturer's user manual provided in your InfoCase for complete operating instructions.

---

---

## ROOF AIR CONDITIONING SYSTEM WITH BLUETOOTH CONTROL



### Cooling Operation

- Press the selector button to the "Low Cool", "High Cool", or "Auto".
- Set the temperature control to the position that is the most comfortable to you. When the temperature of the air entering the air conditioning unit rises a few degrees above the setting you have selected, the A/C will turn on. When the temperature of the air entering

the air conditioning unit drops below the selected setting, the A/C will turn off. When the air conditioner is in the cooling mode, it will continue to cycle on and off until the selector button is turned to another operation mode.

- Position the louvers to the desired direction the discharge air is to flow.

### **During Cooler Nights**

When outdoor temperatures drop in the evening or at night below 75 degrees F, the temperature control needs to be set at midpoint between “Warmer” and “Cooler”. If the setting is at “Cooler”, the evaporator coil may become iced up and stop cooling. During the day when temperatures have risen to at least 75 degrees F, reset the thermostat switch to the desired setting.

*NOTE: Should icing up occur, it is necessary to let the evaporator coil defrost before normal cooling operation is resumed. At this time, operate the air conditioning unit in the “High Fan” position with the system at maximum airflow. When increased or full airflow is observed, the evaporator coil should be clear of ice.*

### **Further Information**

Refer to the air conditioner manufacturer’s information in your InfoCase for complete operating instructions, including Bluetooth operation. The app can be downloaded to your smart-phone via the appstore.

---

---

### **AIR CONDITIONER FILTER**

The two (2) washable filters should be checked monthly for dirt build-up and cleaned or replaced as needed. It is located in the ceiling-mounted air conditioner grille in the lounge area.

### **Further Information**

See the air conditioner manufacturer’s information in your InfoCase for removal and cleaning instructions.

---

---

### **HYDRONIC HEATING SYSTEM**

The Hydronic Heating System in your RV provides a continuous supply of hot water and interior heat. This system features a 12-volt DC powered diesel burner (which utilizes on-board diesel fuel) and a 120-volt AC electric heating element, along with a propylene glycol-based antifreeze and water heating solution to give you the luxury of quiet, continuous warmth in your motorhome.

*NOTE: DO NOT turn off the batteries or DC power if the heating system is running. The batteries and DC power must remain on for 3 minutes after the heater is shutdown to ensure proper heating system shutdown.*

### **NOTICE**

When the water system is in use, the thermostat should never be set below 40°F to prevent freeze damage to components.

### **Heat Sources**

*NOTE: The diesel burner is the primary heat source. It becomes secondary to the electric heat source until it cannot meet the demand. The burner will start if it is enabled.*

**Diesel** - Activate the Furnace, and the burner will light and go through its normal operating cycle. It will cycle on/off in 5 to 10 minute intervals.

## SECTION 4 – APPLIANCES AND SYSTEMS

### NOTICE

If operating the heating system, always maintain 1/4 tank of diesel fuel to ensure proper system operation. The heating system will shut down if the diesel fuel tank is below 1/4 tank. The system is designed to prevent you from depleting the entire fuel tank.

**Electric** - Turn on AC Heating element depending on the service available and the power load of the coach. Example: If you have 30 amp or only 20 amp service available.



AC Electrical Element Selector  
(Located near monitor panel)  
-Typical View

### Basic Operation



LCD Panel  
(Located near monitor panel)  
-Typical View

- **Press anywhere on the touchscreen to activate the menu options.**



- **Hot Water Icon**, the system will cycle and maintain the hot water heat exchanger so that hot water is available on demand.

*NOTE: In order for the hot water to be maintained, either the electric icon or the burner icons must be selected. (Or both).*



Hot Water Icon  
-Typical View

- **Electrical Element:** When the Electrical Element icon is selected the 1500 watt 120V element will activate and provide supplemental heat to the coolant. When both the Electrical Element and Burner icons are selected the system will automatically prioritize using heat from the Electrical Element. If there is a greater heating demand on the system the burner will automatically engage and heat the glycol.



Electrical Element Icon  
-Typical View

- **Burner**, when the burner icon is selected the diesel heater will run and keep the coolant hot and ready for hot water and heat. The heater will cycle on and off, maintaining the temperature in the coolant.



Burner Icon  
-Typical View

- **Interior Temperature setting**, The temperature inside the motorhome can be set by sliding the temperature bar to the desired temperature, or by pressing the + and - icons under the temperature bar.



Temperature adjust bar and + and -  
Temperature adjustment icons.  
-Typical View

## Coolant Tank



### **WARNING**

DO NOT open the Coolant Tank when  
HOT.

## SECTION 4 – APPLIANCES AND SYSTEMS

### NOTICE

This system is filled with a 40/60 mix of DEX-COOL extended life antifreeze and deionized water. No substitutions shall be permitted or damage to system may occur.



Coolant Tank

(Located below dinette seat - remove screws and panel to access)

- Fluid should be within 1" at the top of the tank.
- Check antifreeze/water heating solution level monthly.

**DO NOT open tank when HOT.**

### Hot Water

The Hydronic Heating System allows water to be heated as it is being used. A continuous supply of hot water is obtained through a tank-less, on-demand hot water system with restricted flow.

### Interior Heat

This system is also equipped with a circulation pump, which allows individual interior heating. Whenever the room thermostat calls for heat, the water heating solution is circulated through interior heat exchangers (similar to radiators) located throughout your RV that distributes heat quietly and evenly.

The Hydronic Heating System can be operated off of the 120-volt AC electric heating element or the 12-volt DC diesel burner.

*NOTE: Please note that the diesel burner is the primary heat source for heating both the interior and the domestic hot water (such as when cool ambient temperatures exist and/or when there is a high demand for domestic hot water).*

It is recommended that when starting up your RV in extreme cold weather conditions or when you are planning on taking a longer shower, to turn on the diesel burner switch located on your interior control LCD panel.

If you normally run the Hydronic Heating System off of the 120-volt AC electric heating element only, it is recommended to fire up the diesel burner monthly as routine maintenance.

### Increasing and Decreasing Water Temperature



### WARNING

Increasing water temperature may result in scalding and serious injury.

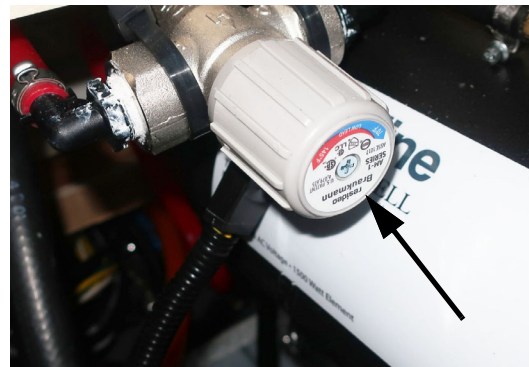

Hydronic Heating System Tempering Valve  
(Located below dinette seat - remove screws and panel to access)  
-Typical View

A tempering valve is located below the dinette seat for regulating the temperature of the hot water.

Turning the tempering valve an 1/8 of a turn either way will dramatically increase or decrease the water temperature.

- Turn tempering valve COUNTER-CLOCKWISE to INCREASE water temperature.
- Turn tempering valve CLOCKWISE to DECREASE water temperature.

See “*Winterizing Procedure*” in Section 6 - *Plumbing (ANTIFREEZE FILL PROCEDURE)* for complete instructions in winterizing your Hydronic Heating System. It will be winterized along with the rest of the RV water systems.

<b>NOTICE</b>
Do not blow out Hydronic Heating System. Failure to comply may result in system damage.

### **Further Information**

Read the operating, safety, and maintenance information as well as troubleshooting and parts and service information provided in the Hydronic Heating System Operation Manual in your InfoCase.



## SECTION 5 – ELECTRICAL

---

Your motorhome is equipped with an electrical system consisting of two separate voltages:

- 12-volt DC system (battery current); and
- 120-volt AC system (household current)

The 12-volt system consists of two internal power sources, while the 120-volt system is operated from an outside power source or the optional 120-volt generator.

---

### ELECTRICAL CAUTIONS

- Careless handling of electrical components can be fatal. Never touch or use electrical components or appliances while feet are bare, while hands are wet, or while standing in water or on wet ground.
- Improper grounding of the vehicle can cause personal injury. Do not plug the utility power cord into an outlet which is not grounded and do not adapt the plug to connect to a receptacle for which it is not designed.
- Do not attach an extension cord to the utility power cord.
- Be sure that all electrical appliances to be used contain 3-prong plugs for proper grounding.
- Avoid overloading electrical circuits. Replace fuses or circuit breakers with those of the same size and amperage rating only. Never use a higher rated fuse or breaker.
- Use caution when handling or working near electrical storage batteries. Always remove jewelry and wear protective clothing and eye covering. Avoid creating sparks.

---

### WINNEBAGO X ECOFLOW POWER KIT PRO MONITOR PANEL

#### -If Equipped

The EcoFlow system Monitor Panel is used to conveniently control and monitor multiple electrical systems and power sources from one screen. This system contains a 5-in-1 power management controller (the power hub) which includes an inverter, a step-down converter, and multiple converters for solar charging and alternator charging. The power hub is combined with a 48V EcoFlow battery. The power hub charges this battery and also puts out 12V DC and 110V AC power. The EcoFlow monitor panel is located over the passenger side main door.

#### EcoFlow Start Up procedure

These steps must be followed to properly start up the EcoFlow system.



Ensure the breakers are in the “ON” position (flipped to the right hand side as shown above).

-Typical View

# SECTION 5 – ELECTRICAL



EcoFlow Home Screen- the arrow points to the power button. Press and hold for 3 seconds to turn the power ON. (Press for 0.5 seconds to turn the screen on and off).  
-Typical View



The output screen accesses controls to the output AC and DC.  
-Typical View

## Features and Options



Selecting the System from the main menu will display available time, battery charging/discharging, battery state of charge (SoC) percentage, and temperature.  
-Typical View

## EcoFlow Shore Power Settings



On the home screen, tap the screen inside the input box to open the input control panel.  
-Typical View



The input screen shows total charging power in Watts, energy generated in watt-hours, and accesses controls of the alternator, Solar, and AC shore power.  
-Typical View



While on the input control panel screen, tap the settings bar icon in the upper right hand corner to open the AC charging current screen.  
-Typical View



On the AC charging current screen, you can adjust the AC charging current to set charging power to the battery. Less charging current will result in less fan noise.

-Typical View

### Shut down procedures

These steps must be followed to properly shut down the EcoFlow system.



Select the input screen  
-Typical View



Ensure all inputs are turned to the OFF position as shown.

-Typical View



EcoFlow Home Screen- the arrow points to the power button. Press and hold for 3 seconds to turn the power OFF. (Press for 0.5 seconds to turn the screen on and off).

-Typical View

### **POWER CORD – EXTERNAL (DETACHABLE)**

(Shoreline)



### **WARNING**

Do not use an extension cord. Improper sized cords, damaged cords, and poor connections can lead to fire, which can result in death or serious injury.

## SECTION 5 – ELECTRICAL



### WARNING

Do not connect the external power cord to any receptacle until you have verified proper polarity and grounding. Be sure all prongs of the supply cord are properly plugged into the receptacle. Failure to observe can result in death or serious injury.

To connect to an external power source, plug the adapter end into the sidewall SmartPlug plug-in (located above the rear driver side wheel) and the receptacle end to a suitable power outlet box.



SmartPlug in open position.  
(Located on the driver's side wall.)  
-Typical View



### WARNING

This connection is for 110/125 Volt AC, 60 Hz 30 Ampere supply. Do not exceed circuit rating. Exceeding the circuit rating may cause a fire and result in death or serious injury.

The power cord is designed to ground the electrical system through the receptacle. It is also designed to carry the amperage output of most campground outlets. If the electrical receptacle to

be used is designed to mate with the prongs of the power cord plug, the electrical connection can be expected to carry rated load.



SmartPlug in closed position.  
(Located on the driver's side wall.)  
-Typical View



### WARNING

Service inlet access must be closed when utility connections are not in use.

## Shore Power Fuses or Breakers

Most campgrounds are equipped with a fuse or circuit breaker at the receptacle (which we recommend shutting off before engaging or disengaging the power cord.) This protects the park's wiring, as well as the power cord on your vehicle from electrical damage. If electrical power fails, contact the park attendants and have them check the fuse or breaker for your supply receptacle.

## CIRCUIT BREAKERS – HOUSE 120-VOLT AC

The breaker panel protects all 120-volt components in the motorhome from either an overload on the circuit or a short in the wiring or component itself. When an overload or short develops, the breaker will open preventing damage to the system.

Shut off the equipment (example: roof air conditioner) and allow a brief cooling period. Then reset the breaker by moving the switch to “Off” and back to “On”. If the breaker is continually tripped and no overload is evident, have the system checked for a short in the wiring or the appliances.



120-Volt Circuit Breakers  
-Typical View

*NOTE: Typical view of breaker panel. Breaker arrangement may vary according to appliance and equipment options. Fuses and breakers are labeled on panel.*

---

---

### **ELECTRICAL OUTLETS – HOUSE 120-VOLT AC**

A number of standard household electrical outlets are provided throughout the motorhome for connecting small appliances such as televisions, radios, toasters, etc.

An exterior outlet is also located on the outside on an exterior sidewall.

---

---

### **GROUND FAULT CIRCUIT INTERRUPTER**

Bath, galley, and exterior outlets are connected to a GFCI (Ground Fault Circuit Interrupter), which is an extremely sensitive circuit breaker that will help to protect against severe electrical shock if a ground fault develops. If such a condition occurs, the GFCI will break the circuit by turning off the power to the

protected outlets. Should this occur, unplug all the appliances on that circuit and press the reset button on the GFCI equipped outlet.

If the GFCI keeps tripping, have the electrical system checked and repaired, if necessary, before using again.

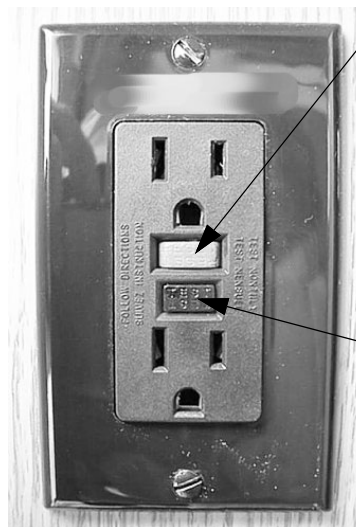

GFCI Outlet  
(Ground Fault Protector)

- Push to Reset circuit after monthly testing or ground fault tripping.
- Push to Test at least monthly. Should break circuit. Press Reset button to reconnect.



### **WARNING**

The GFCI will not completely eliminate the risk of electrical shock. Infants and small children may still be affected.

## SECTION 5 – ELECTRICAL

### ECOFLOW BATTERY AND CHASSIS BATTERY ACCESS

#### Ecoflow Battery

The Ecoflow battery is located inside the driver's side rear access panel.

Remove the driver's side rear access panel to service battery.

**NOTE: DO NOT** turn off the batteries or DC power if the heating system is running. The batteries and DC power must remain on for 3 minutes after the heater is shutdown to ensure proper heating system shutdown.



-Typical View



#### **CAUTION**

The driver's side rear access panel must be closed and latched. Failure can cause injury.

#### Chassis Battery

The chassis (starting) battery is located in a compartment "well" in the floor beneath carpet ahead of the driver seat.

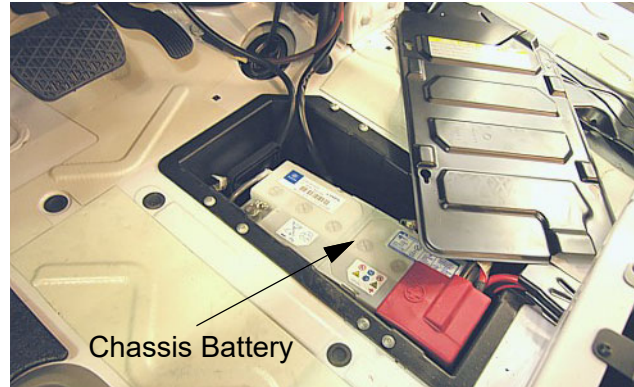

#### Chassis Battery Connector

The chassis battery connector is located to the right of the accelerator pedal in the driver side foot well, behind access panel.

**NOTE:** Ensure that the ignition key is in the Off position and the key is removed, and wait 10 minutes before disconnecting.



Chassis Battery Connector  
(Located to the right of the  
accelerator pedal behind  
access panel)

#### Further Information

See the chassis manual provided in your InfoCase for details on access and servicing.

#### **NOTICE**

Always refasten battery retainers when returning a battery to the compartment.

---

---

## **CIRCUIT BREAKERS AND FUSES – HOUSE 12-VOLT DC**

All 12-volt circuits and equipment in the coach area of the motorhome are protected by either a fuse panel or breaker panel. When a circuit is overloaded or a short develops in any part of the system, a fuse or breaker will shut down that circuit. If this happens, turn off all affected lights or appliances and reset the breaker or replace the fuse with a new one of equal amperage rating.

### **House 12-Volt Fuses**

A label on the panel states the amperage rating and circuit protected for each fuse.

The fuse panel is located on the dinette cabinet.

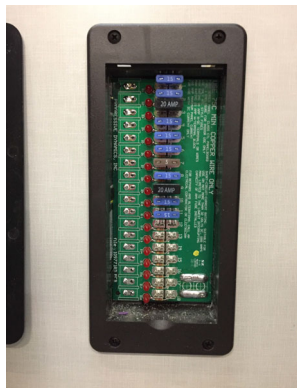

House 12-Volt Fuses  
-Typical View

The fuse panel accepts only blade type plug-in fuses. Always replace fuses with those of the same amperage rating.

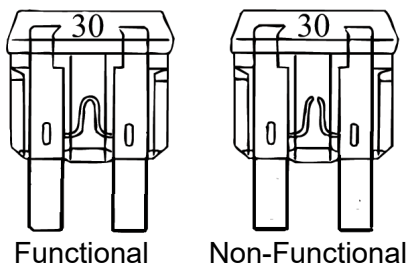

### **Battery Charge Meter**

See related item under “Systems Monitor Panel” in *Section 4 - Appliances*.



# SECTION 6 – PLUMBING

## FRESH WATER SYSTEM

The Fresh Water System provides water to the galley sink, shower, bathroom lavatory, toilet, water heater, and exterior shower. Water may be supplied by either of two sources:

- A fresh water tank and water pump located within the motorhome, or
- Any external fresh water source to which the motorhome may be connected, known as “city water”.

The fresh water tank is filled through the tank fill connection.

## Water Pressure Regulators

Because city water pressure varies from location to location, we recommend obtaining an in-line water pressure regulator to prevent damage to any components, connections, and seals in your fresh water system.

These devices simply connect in-line between the supply hose and the city water input on the coach. We recommend regulators that control water pressure to **50 psi. max.**

Water pressure regulators are commonly available at most RV dealerships and many large retail discount or home supply centers.

## Method 1 - Filling the Fresh Water Tank Through Tank Fill Connection

 <b>WARNING</b>
Potable water only. Sanitize, flush, and drain water tank before using. See owner’s manual for instructions, care, and maintenance information. Failure to maintain tank can result in death or serious injury.

Always fill the fresh water tank at an approved potable water filling facility or a known purified drinking water source.

The tank is filled through the Tank Fill Inlet on the water center panel behind the passenger side rear door.

1. Attach hose to the Tank Fill Inlet.

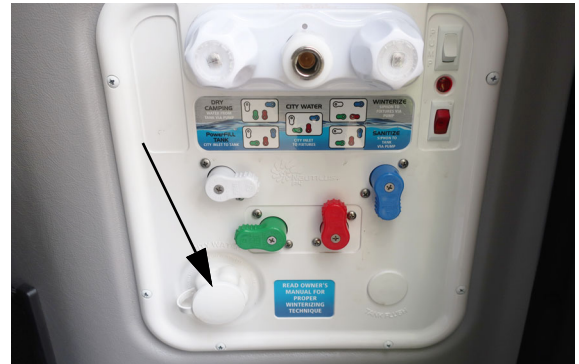

Tank Fill Inlet  
(Located behind the passenger rear door)  
-Typical View

2. Configure the levers on the panel to reflect the “Power Fill Tank” setting as indicated by the picture instructions on the Water Center Panel.
3. Use the level display on the monitor panel to oversee filling of the tank, or when the tank is full, water will flow from tank vent tube beneath the coach.

<b>NOTICE</b>
Do not leave fresh water connection unattended when filling tank. Failure to comply may result in tank expansion and property damage.

4. Turn OFF city water supply and disconnect hose from the Tank Fill Inlet.
5. Set the Water Panel back to the “Dry Camping” setting.

## SECTION 6 – PLUMBING

---

---

### WATER PUMP

When your coach is not connected to a city water supply, water is supplied from the fresh water tank by a water system demand pump. A demand pump is designed to run only when you are using water. When you open a faucet, the waterline pressure drops and the pump begins to run, and it will continue to run as long as the faucet is open. When you close the faucet, the line pressure backs up to the pump, and it shuts itself off.

The pump is self-priming and will run briefly to build up line pressure when the Water Pump switch is first turned on. See “Initial Waterline Priming” for instructions on using the water system for the first time.

### Water Pump Strainer

The pump is equipped with a cleanable strainer to capture any possible tank-borne particles that could damage pump components.

*NOTE: We recommend that you check and clean the strainer after each tankful of water during the first few uses of the Water Pump system. Thereafter, remember to check it at least yearly, and be sure to empty water from it during winterization procedures.*



Water Pump Strainer  
-Typical View

### To Clean Pump Strainer

- Ensure all Water Pump switches are OFF.

- Twist the inlet cap (bowl) “counter-clockwise” to unscrew from the strainer assembly.
- Remove the bowl and pull the strainer screen out of the bowl to tap out any particles and rinse clean.
- Insert the strainer screen back into the bowl, then screw the bowl back onto the strainer assembly.

*NOTE: You must also empty the strainer when winterizing your coach to avoid water freezing and cracking the filter bowl.*

### Water Pump Switch

The Water Pump switch is located on the top right of the Water Center Panel behind the passenger rear door.



Pump switch  
-Typical View

While the switch is “ON”, the pump will automatically supply water as it is needed.

We recommend that you turn the Water Pump switch off whenever you will be away from the vehicle or not using the water system. In time, a slow leak in a faucet could drain the water tank, fill the holding tank, and discharge the house batteries.

### Initial Waterline Priming

1. Ensure that all water drain valves are closed, including water heater valve.
2. Turn Water Pump switch to “OFF” position.
3. Fill water tank.
4. Open all faucets, hot and cold.

5. Turn ON the Water Pump switch.
6. Close each faucet as it begins to deliver a steady stream of water (close cold water first). Leave hot water faucets on until they also deliver a steady stream of water. This will ensure that the water heater is filled with water.
7. Check to ensure the Water Pump stops soon after all faucets have been closed.
8. The Water Pump is now ready for automatic operation. The pump will start when a faucet is opened and stop when the faucet is closed.

### Water Pump Location



Water Pump  
(Located below Water Center Panel - remove panel to access)  
-Typical View

### Further Information

Refer to the Water Pump manufacturer’s operation, care, and maintenance information provided in your InfoCase.

---



---

## DISINFECTING YOUR FRESH WATER SYSTEM

**(As required by NFPA®1192 Standard on Recreational Vehicles)**

To ensure complete disinfection of the potable water system, it is recommended that the following procedure be followed on a new

system, one that has not been used for a period of time, or one that could have become contaminated.

This procedure is also recommended before long periods of storage, such as over winter.

### Disinfecting with Sanitize setting

1. Turn the levers on the Water Center Panel to the “Sanitize” position as indicated by the picture instructions on the Water Center Panel.
2. Prepare a chlorine solution using 1 gallon of water and 1/4 cup of household chlorine bleach (sodium hypochlorite solution).
3. Attach a siphon tube to the tank fill port and turn the pump on to siphon the chlorine solution into the tank.



Attach a siphon tube then place it in the chlorine solution container and turn the pump on to begin siphoning contents.  
(typical view)

4. Use 1 gallon solution for each 15 gallons of tank capacity. This procedure will result in a residual chlorine concentration of 50 ppm in the water system.

*NOTE: If a 100 ppm concentration is desired, use 1/2 cup of household bleach with 1 gallon of water to prepare the chlorine solution. One gallon of this solution should be used for each 15 gallons of tank capacity.*

## SECTION 6 – PLUMBING



### WARNING

Chlorine is poisonous. Do not misuse. Recap bottle and clean all utensils after use.

5. Complete filling of tank with fresh water.
6. Turn off Heating System and allow to cool. See “Heating System - Furnace and Indirect Water Heating” in *Section 4 - Appliances and Systems*.
7. Open each faucet in the motorhome and run the water until a distinct odor of chlorine can be detected in the water discharged. Do not forget the hot water faucets.
8. Let the system stand at least 4 hours when disinfecting with 50 ppm residual chlorine. *(If a shorter time period is desired, then a 100 ppm chlorine concentration should be allowed to stand in the system for at least 1 hour).*
9. Drain the water tank and refill with fresh water.
10. Open each faucet again and run fresh water to flush chlorinated water from the lines. Run the water until there is no odor of chlorine detected in the water discharged. Do not forget the hot water faucets.
11. Turn water center panel to the city water configuration.
12. Turn on water heater.
13. Water system is now disinfected.

### Disinfecting with Tank Fill

When disinfecting through the tank water fill, an external cartridge-type water filter assembly must be connected in-line between the city water hose and the tank fill inlet to add disinfecting solution to the tank. These filters are commonly available at most RV supply stores.

*NOTE: If you do not have an in-line cartridge filter, see City Water Hose/Tank Disinfection following this procedure for an alternate method of adding bleach solution to your tank.*

1. Turn off Heating System and allow to cool. See “Heating System - Furnace and Indirect Water Heating” in *Section 4 - Appliances and Systems*.
2. Turn the water center panel to the “winterize” setting as indicated by the instructions on the water center panel to bypass water heater to prevent filling the water heater tank with a high concentrate of chlorine.
3. Remove the filter cartridge and pour 1/4 cup of household chlorine bleach (sodium hypochlorite solution) for each 15 gallons of tank capacity into the empty filter canister, then screw the canister back onto the filter base.



### WARNING

Chlorine is poisonous. Do not misuse. Recap bottle and clean all utensils after use.

This solution will result in a residual chlorine concentration of approximately 50 ppm in the water system. *(If a 100 ppm concentration is desired, use 1/2 cup of household bleach for each 15 gallons of tank capacity).* The bleach will be drawn into the tank when the city water is turned on.

4. Fill the tank completely, then open each faucet in the motorhome and run the water until a distinct odor of chlorine can be detected in the water discharged. Do not forget the hot water faucets.
5. Let the system stand at least 4 hours when disinfecting with 50 ppm residual chlorine. *(If a shorter time period is desired, then 100 ppm chlorine concentration should be allowed to stand in the system for at least 1 hour).*
6. Drain the fresh water tank.

7. Install the filter cartridge into the filter canister, then refill the tank with fresh water.
8. Open each faucet again and run fresh water to flush chlorinated water from the lines. Run the water until there is no odor of chlorine detected in the water discharged. Do not forget the hot water faucets.  
*(You may need to leave a hot water faucet open for some time to flush the water heater with clean water. You may also want to turn the water heater off until this is done to avoid wasting energy trying to heat “unused” water).*
9. Water system is now disinfected.

### **City Water Hose/Tank Disinfection**

As an alternative way to disinfect your tank, connect a city water hose to your motorhome and pour the bleach into the other end of the hose using a funnel. Hold the hose upright to avoid draining the bleach.

Connect the hose to a city water hydrant to force the bleach into the tank and fill the tank with water.

This method has the additional benefit of disinfecting the city water hose at the same time.

### **Continuous Tank Disinfection (Superchlorination)**

Some RVers like to ensure continuous sanitation of their fresh water tank by “superchlorination”—maintaining an effective low level of chlorine in the tank at all times.

- Add 1 teaspoon of household chlorine bleach (sodium hypochlorite) to your tank for each 10 gallons of tank capacity. When you fill the tank, this will result in a 6.7 ppm level of chlorine, which should kill harmful bacteria and slime-forming organisms.
- Chlorine may be removed from drinking water by the cold water filter at the galley faucet (if equipped) or by installing an activated carbon water purifier at the galley sink cold water line or a separate drinking water faucet with filter.
- Superchlorination does not affect city water usage, only the fresh water tank.

---

---

### **SHOWER HOSE VACUUM BREAKER**

After using the shower, you may notice water dripping from the shower faucet assembly. The dripping results when vacuum in the shower hose (after closing the shower faucet) slowly releases and allows water remaining in the hose to drain down. This is a normal function of the shower valve assembly and is not a leak or defect.

If items are placed into the shower tub before shower valve vacuum release is complete, they may become wet.

---

---

### **EXTERIOR SHOWER/WASH STATION**

The exterior wash station feature allows you to do things such as rinse off sand or salt after a swim, rinse off muddy boots, or bathe your pet outside the motorhome. The water pump switch is located in the water center panel, inside the rear passenger door.

*NOTE: The exterior wash station detachable hose is shipped loose in a misc. parts box in the shower for delivery.*

The shower/wash station is not an access point for potable water, and is not to be used to access potable water.

The shower/wash station includes hot and cold water (located inside the rear passenger side door).

## SECTION 6 – PLUMBING



Exterior Shower/Wash Station  
(located behind rear passenger side door,  
shown with shower hose hooked up.  
-Typical View)

---

---

### TOILET

#### -If Equipped

*NOTE: See the toilet manufacturer's user guide provided in your InfoCase for complete operating instructions, care and cleaning instructions, and safety precautions.*

The toilet in your motorhome has a waste holding tank, which you need to empty when full. The waste holding tank is located in the left sidewall compartment.

*See "Before Use" in the toilet manufacturer's user guide provided in your InfoCase for complete instructions before using the toilet.*

When the Level Indication slide turns from green to red, the waste holding tank is full.

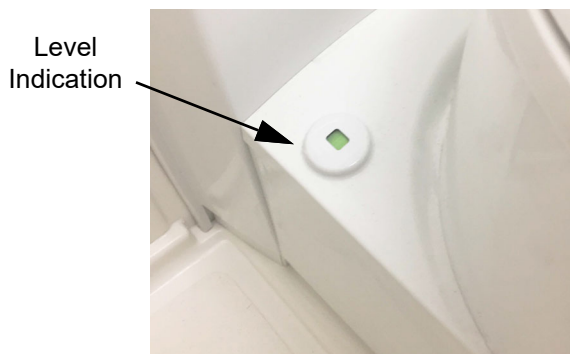

To open the waste holding tank compartment, use the key (located on key ring) to unlock the compartment door then push both buttons in at the same time while pulling the door open.

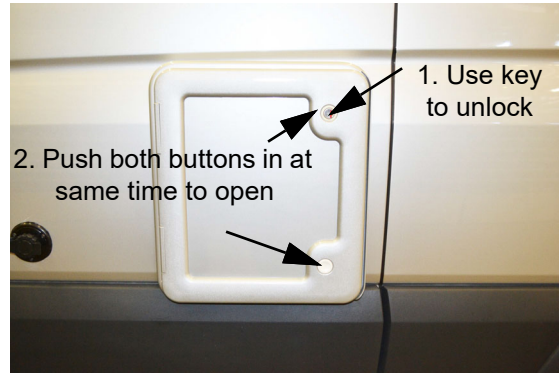

Waste Holding Tank Compartment  
(Located on left sidewall)- Typical view

*See the toilet manufacturer's user guide provided in your InfoCase for complete instructions on emptying the waste holding tank.*

#### Important "Don'ts"

- Don't use facial tissue or regular toilet tissue in the RV toilet. These will not disintegrate sufficiently and will often cling to the sides of the holding tank. Toilet tissue made specifically for use in RV toilets and holding tanks is available at most RV supply centers.
- Don't dispose of sanitary napkins or other non-dissolving items in the toilet.
- Don't put automotive antifreeze or caustic chemicals, such as laundry bleach or heavy detergents into the toilet or holding tank. These products may damage plastic or rubber parts in the system.

See winterizing instructions at the end of this section to prepare the toilet for storage in freezing conditions.

#### Further Information

See the toilet manufacturer's operation information in your InfoCase for complete operating, care, and maintenance information.

**WASTE WATER SYSTEM –  
WASTE PUMP**

**(Holding Tanks)**

The drainage system is self-contained and uses a holding tank to contain the waste water until it can be dumped at an appropriate waste water disposal site. This means you can use the sinks and shower even in areas where utility hookups are not available.

The gray water holding tank contains the waste water from the galley sink and shower.

See “Specifications” in *Section 1 - Introduction* for tank capacities for your model.

**Waste Pump**

The 12-volt Waste Pump disposes holding tank waste through a small diameter sewer hose.

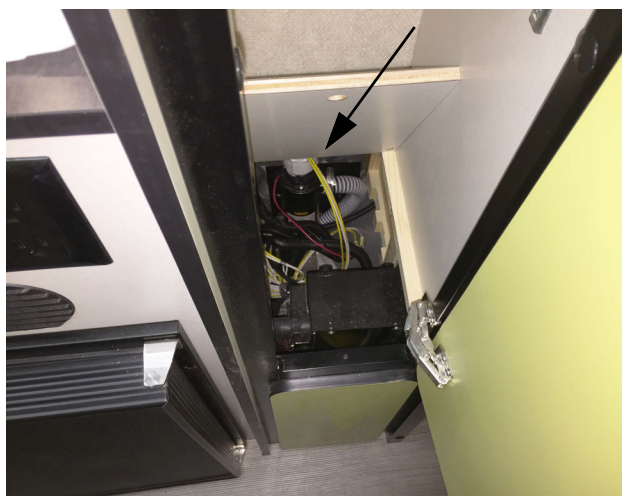

**Waste Pump**  
(Located beneath pantry cabinet -  
lift access panel)  
-Typical View

*NOTE: If Waste Pump stalls, check breaker in the load center. If problem persists, remove end cap and manually turn pump shaft (located on the end of the Waste Pump) with a screwdriver.*

**Further Information**

For further Waste Pump operating and troubleshooting information, see the manufacturer’s user guide provided in your InfoCase.

**Dumping Holding Tanks**

1. Remove sewage drain hose from storage compartment (located under the passenger rear door).

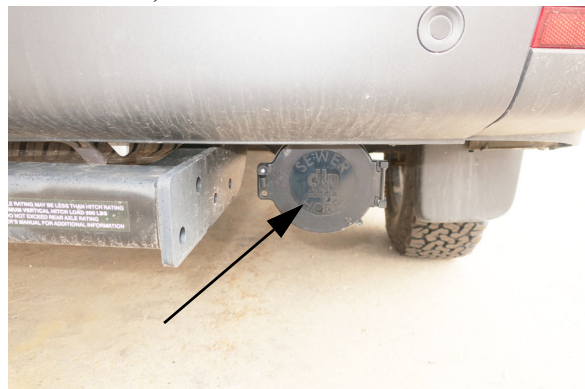

**Sewage Drain Hose**  
(Located under the passenger  
rear door)  
-Typical View

2. Remove dust cap from sewage drain outlet and connect sewage drain hose. Be sure it is firmly attached.

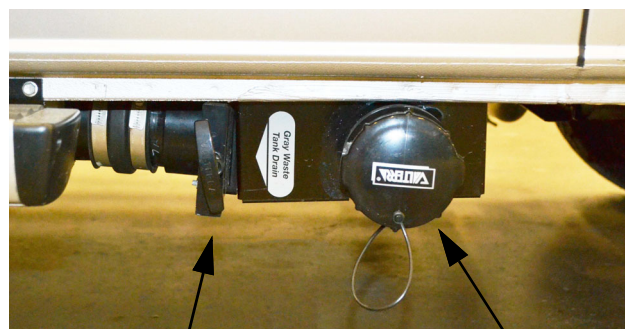

**Gray Waste Tank Drain Valve**      **Sewage Drain Outlet Valve**

**Holding Tank Drain Valves**  
(Located on driver side in front of rear tire)  
-Typical View

3. Place the outlet end of sewage drain hose into disposal opening.

## SECTION 6 – PLUMBING

4. Open the Gray Waste Tank Drain valve. Be sure there are no sags in the hose to ensure complete drainage. Close Gray Waste Tank Drain valve as soon as tank is empty.
5. Add an odor control chemical to the sewage holding tank through the toilet. These chemicals are available at most RV stores.
6. Rinse sewage drain hose thoroughly with water before stowing.

*NOTE: We recommend that you dump all holding tanks before traveling to avoid carrying unnecessary weight.*

### Using On-Site Sewer Hook-Ups

The sewage drain hose may remain attached to the sewage drain outlet while the motorhome is parked and connected to an on-site sewage hook-up.



## WARNING

Service inlet access must be closed when utility connections are not in use.

When using a sewer hook-up, keep the dump valves closed until a tank becomes full or when preparing to leave the site. This keeps the solids in suspension, allowing them to be carried out with the liquids when the dump valve is opened. If the valve is left open, the liquids will drain off, leaving solids in the tank. Should this accidentally happen, disconnect the hose, fill the tank about half full with water, and drive a few miles to dislodge the solids. A few starts and stops will aid in the process. Then reconnect the hose and drain in the normal manner.

*NOTE: Always keep sewage drain outlet capped while sewage connection is not in use.*

### Holding Tank Level Indicators

See “Systems Monitor Panel” in *Section 4 - Appliances* for further information on the monitor panel and checking tank levels.

See “Specifications” in *Section 1 - Introduction* for tank capacities for your model.

---

---

## WATERLINE AND TANK DRAIN VALVES

The waterline and tank drain valves are used to drain water from the water tank and the water supply lines when preparing the motorhome for storage or when sanitizing the water system.

See the “Water System Drain Valve Locations” chart at the end of this section for locations on your model.



Waterline and Tank Drain Valves  
(shown in the closed position)  
(See the “Water System Drain Valve Locations”  
chart at the end of this section for locations on  
your model)  
-Typical View

## **WINTERIZING PROCEDURE**

Your motorhome is equipped with a manually operated waterline winterization system for your convenience in winterizing fresh waterlines. This action is necessary for storage in cold climates, as well as operating during freezing conditions. The winterization process blows out left over water in the pipes, and adds antifreeze to prevent pipes from freezing and bursting, possibly causing extensive damage. Certain areas of your water system require additional attention and disconnecting or blowing out these lines may be required. Be sure all water is drained from the system.

*We recommend performing Step 1 “Blow Out Procedure” and Step 2 “Antifreeze Fill Procedure” to properly protect the system.*

### **Step 1 – Blow Out Procedure (Drain and purge waterlines using compressed air)**

1. **Level the Motorhome.** If the motorhome is not level, there may be “low points” in waterlines that can trap water in the lines and prevent it from draining properly.
2. **Set the Winterization Valve #2 to the “winterize” configuration.**



Water Center Panel in “Winterize” configuration (Panel located behind passenger rear door).  
-Typical view

3. **Turn OFF the Heating System and water pump by using the control panel (located near the monitor panel).** The water pump

can also be switched off at the Water Center Panel (located at the top right of the panel). This switch can be turned off at either station, for convenience. (The switch at the Water Center Panel will illuminate if the pump is on).



Water heater controls on Systems Monitor Panel  
-Typical view



Water pump switch location on Systems Monitor Panel  
-Typical view

## SECTION 6 – PLUMBING



Water pump switch location  
on Water Center Panel  
-Typical view

4. **Open all waterline and tank drain valves** (See “Water System Drain Valve Locations” chart at the end of this section for locations of drain valves on your model).

*NOTE: To make sure that all water drains properly from the water container, place a big enough vessel underneath the drainage socket of the drain valve (>2.64 gallons (10 liters)).*



Waterline and Tank Drain Valves  
(shown in the closed position)  
(See the “Water System Drain Valve Locations”  
chart at the end of this section for locations on  
your model)  
-Typical View

**⚠ CAUTION**

Hot water can escape from tank causing injury. Operate drain valve only when the tank water is cold.

5. **Empty the water pump strainer filter bowl to avoid water freezing and cracking the filter bowl.** (located below the Water Center Panel)



Water Pump  
(Located below Water Center Panel - remove  
panel to access)  
-Typical View



**To Clean Pump Strainer**

- Twist the inlet cap (bowl) “counter-clockwise” to unscrew from the strainer assembly.
- Remove the bowl and pull the strainer screen out of the bowl to tap out any particles and rinse clean.
- Insert the strainer screen back into the bowl, then screw the bowl back onto the strainer assembly.

-Typical view

6. **Connect Air Pressure.** Connect a “blow-out” plug to the city water inlet (located on the lower left of the Water Center Panel). Then, use a compressed air hose regulated to 30 psi or less to force air through the system. A “blow-out” plug can be purchased at any Winnebago Industries® dealer.

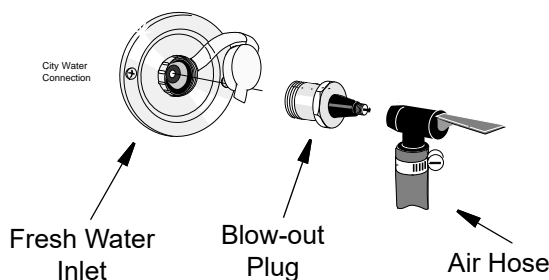

**NOTICE**

Limit air pressure to 30 psi to avoid damage to equipment.

*NOTE: DO NOT burst air into the system. This can damage the water pump. It is better to let air in slowly.*

7. **Drain Exterior Shower/Wash Station.** Attach exterior shower hose, then point shower hose toward ground and squeeze the handle. Turn on the hot faucet, then the cold to drain any water left in the shower and sink lines.

*NOTE: The exterior wash station detachable hose is shipped loose in a misc. parts box in the shower for delivery.*



- Connect shower hose to Water Center Panel faucet (Located behind the passenger rear door on the Water Center Panel), then squeeze handle until water stops flowing.

-Typical view

## SECTION 6 – PLUMBING

8. **Drain Toilet.** Press the toilet flush button and hold until water stops flowing in the toilet.



- Toilet flush button. Hold until water stops flowing.  
-Typical view

9. **Point shower head into shower drain and open shower faucet** (point towards hot, then cold) until water stops flowing, then close.



- Point shower head at the drain and squeeze until water stops flowing.  
-Typical view

10. **Open galley sink faucet** (point towards hot, then cold) until water stops flowing, then close.



- Galley Sink faucet.  
-Typical view

11. **Turn air pressure off.** Disconnect blow-out plug.

### After Disconnecting Air Pressure

12. **Close all waterline and tank drain valves, and all faucets** to avoid contamination by dirt, insects, or rodents.

### Dump and Clean Holding Tank at an approved waste disposal site

13. Remove sewage drain hose from storage compartment (located under the passenger rear door).

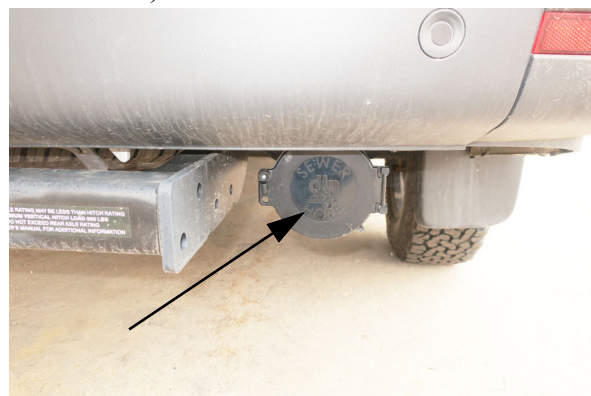

Sewage Drain Hose  
(Located under the passenger  
rear door)  
-Typical View

14. Remove dust cap from sewage drain outlet and connect sewage drain hose. Be sure it is firmly attached.

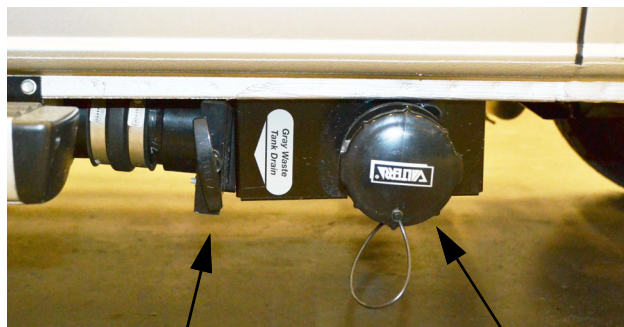

**Gray Waste  
Tank Drain  
Valve**

**Sewage  
Drain Outlet  
Valve**

Holding Tank Drain Valves  
(Located on driver side in front of rear tire)  
-Typical View

15. Place the outlet end of sewage drain hose into disposal opening.
16. Open the Gray Waste Tank Drain valve. Be sure there are no sags in the hose to ensure complete drainage. Close Gray Waste Tank Drain valve as soon as tank is empty.
17. Add an odor control chemical to the sewage holding tank through the toilet. These chemicals are available at most RV stores.
18. Rinse sewage drain hose thoroughly with water before stowing.
19. Close waste tank drain valve and refit the dust cap onto the sewage drain outlet. This will inhibit rust from forming on the valve shafts and prevent entry and contamination by airborne debris, insects, and rodents.
20. Continue with Step 2 - Antifreeze Fill Procedure.

## Step 2 – Antifreeze Fill Procedure (Fill plumbing lines with RV water system antifreeze)

*NOTE: Non-Toxic RV water system antifreeze is available from your dealer and from most RV supply stores and national retail outlets. Follow directions on the container to determine the correct amount to use for your motorhome.*



## WARNING

NEVER use automotive antifreeze/coolant in your RV water system. Automotive coolant/antifreeze contains ethylene glycol which, if ingested, can cause blindness and can be fatal.

The Water Control Panel features a Winterization (diverter) valve with an antifreeze siphon tube to draw non-toxic RV water system antifreeze into the waterlines.

21. Double check that the water control panel is set to the “winterize” configuration as indicated on the water control panel.
22. Attach antifreeze siphon tube on the Water Center Panel.

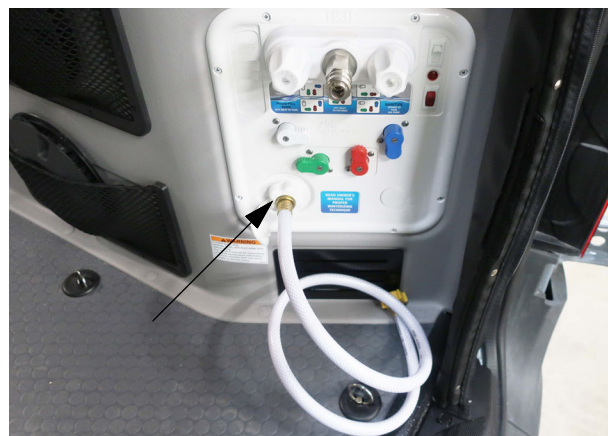

- Antifreeze Siphon Tube attached to the tank fill inlet  
-Typical view

23. Insert the end of the siphon tube into a pail or other container with 2 to 3 gallons of non-toxic RV antifreeze solution.

*NOTE: Ensure that all drain valves are CLOSED before pumping RV antifreeze into the water system. Refer to the “Water System Drain Valve Locations” chart at the end of this section for valve locations on your model.*

## **SECTION 6 – PLUMBING**

---

### **Fill Lines**

24. Turn the Water Pump switch ON.
25. Open each hot and cold water faucet handle/knob in the motorhome - one at a time each in turn until antifreeze solution just begins to flow from the faucet, then close.
26. With the exterior shower/wash station hose connected, point hose toward the ground and squeeze handle until antifreeze solution begins to flow, then disconnect hose. Do this for both wash stations.
27. Press the toilet flush button and hold until antifreeze begins flowing into the toilet. Leave small amount of antifreeze that remains in the bowl.
28. Disconnect Antifreeze siphon tube.

### **When Done Adding RV Antifreeze**

29. Turn Water Pump switch OFF.
30. Leave the Water Control Panel in the “Winterize” configuration until you are ready to bring the motorhome out of storage.
31. Replace the protective cap onto the end of the Antifreeze Siphon Tube to keep out insects and debris when not in use.

### **Fill Drainage System P-Traps**

32. Pour about one cup of RV antifreeze down each drain for the galley sink and lavatory sink. This fills the drain trap pipes to prevent holding tank odors from entering the motorhome during storage.

*Your drainage and fresh water systems are now winterized.*

*See instructions for removal from storage in Section 11 - Maintenance and Storage.*

<b>WATER SYSTEM DRAIN LOCATIONS</b>		
<b>Model</b>	<b>Description</b>	<b>Drain Locations</b>
<b>44N &amp; 44C</b>	<b>Waterline Drains</b>	<ul style="list-style-type: none"> <li>• <b>Waterline and tank drain valves</b>- located behind the sliding entrance door.</li> <li>• <b>Exterior shower faucet</b> - one located on the Water Center Panel behind passenger rear door. Lay shower head on ground and open spray nozzle until drained.</li> <li>• <b>City Water Connection</b> - located on the Water Center Panel behind the passenger rear door. Place the tip of your finger inside the city water connection and gently press the backflow valve (small “button” in center of connector) to drain cold water from the city waterline.</li> </ul>



# SECTION 7 – FURNITURE AND SOFTGOODS

## TABLE (EXTERIOR)

There is a table located on the right side of the motorhome behind the sliding door. (Typical Views shown)

- Lift up the 2 silver latches to release table.

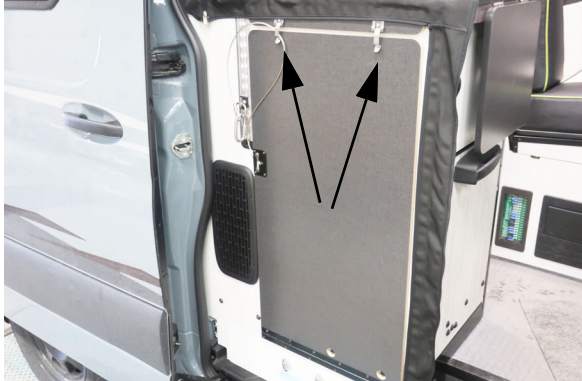

- Slowly lower the table into place.



- The height of the table can be adjusted with the retention pin bar.



## SLEEPING FACILITIES



### WARNING

Sleeping facilities are not intended for use while vehicle is in motion. For safety, passengers must use safety belted seating positions while vehicle is in motion.

## POWER LOFT BED

### -If Equipped

*NOTE: The Power Loft Bed is not intended for storage.*

The Loft Bed is stowed near the cab ceiling.

### To lower the Loft Bed for use

1. Unfasten the safety belt.



## SECTION 7 – FURNITURE AND SOFTGOODS

- Turn the key (located near the monitor panel) to the “ON” position.



- Push the DOWN arrow to lower the Loft Bed.

	<b>WARNING</b>
Keep people away from operating mechanism and pinch hazard areas during use. Failure to do so could cause injury.	

- Maximum Capacity: 500 lbs.
- To avoid injury to young children, do not leave them unattended on the bunk.

*NOTE: This low bunk design may be accessed without the use of a ladder. If needed, a multi-purpose step stool may be used.*

### To store the Loft Bed

- Push the UP arrow until the Loft Bed reaches the ceiling.
- Turn the key (located near the loft bed or monitor panel, depending on model) to the “OFF” position.



- Fasten the safety belt whenever the bed is in the stored position.



### Manual Retraction of Loft Bed

If the Power Loft Bed is malfunctioning you may need to manually retract the loft bed.

1. Remove screws from bottom bunk panel.  
Remove panel and set aside.

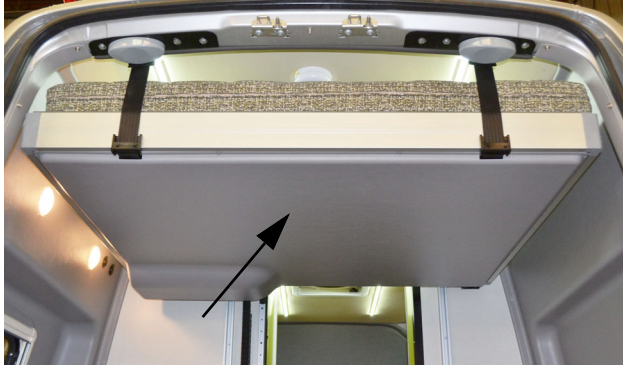

2. Remove Loft Bed manual retractor from InfoCase.



3. Insert manual retractor into loft bed motor (as shown) and turn clockwise to raise the loft bed into stored position.

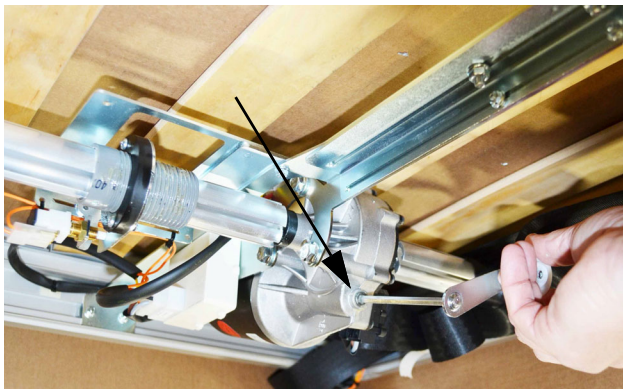

4. Turn the key (located near the monitor panel) to the “OFF” position.



5. Fasten the safety belt whenever the bed is in the stored position.



6. A seat belt storage clip is installed to secure the belt when the bed is down.



## SECTION 7 – FURNITURE AND SOFTGOODS

7. The image below shows the seat belt secured on the storage clip.



- For daytime room darkening or nighttime privacy, pull entire shade upward to desired position.

---

---

### SLIDING DOOR SCREEN ZIPPER ENCLOSURE

The passenger side sliding door has a roll down screen that is secured with 2 zippers and has a magnet strip for easy entering and exiting. Roll up the screen when driving the vehicle.

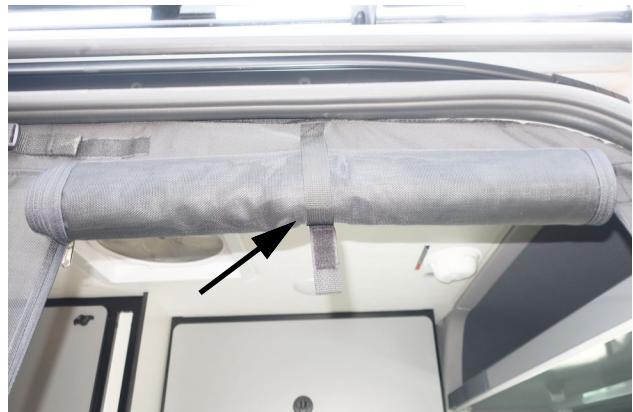

The screen is stored in the rolled up position.  
-Typical View

---

---

### WINDOW SHADES/SCREENS

(Typical View – Your motorhome may differ in appearance)

Your motorhome is featured with multi-positioning window shades and screens that can be used for light filtering, outside airflow, bug protection, daytime room darkening, or nighttime privacy.

- Translucent Screen

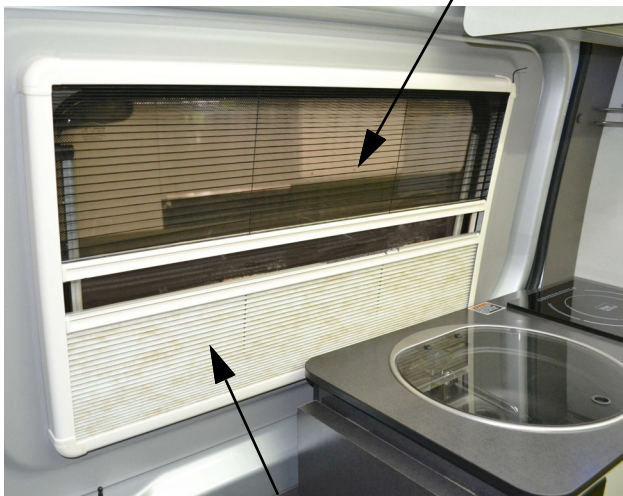

- Shade

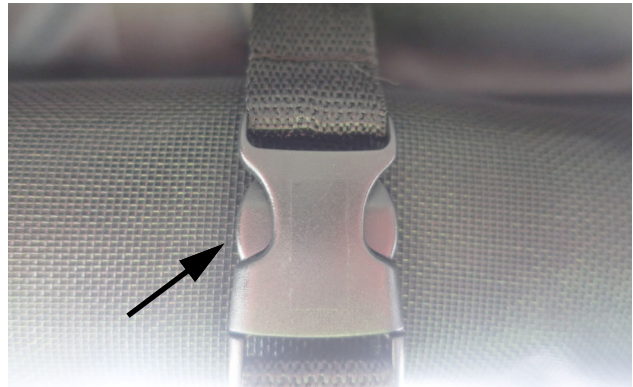

Remove the retention strap to roll down the shade.  
-Typical View

- To lower translucent screen, pull the bottom of the screen straight down until the bottom latch “clicks” into position.
- To raise the translucent screen, pull bottom latch outward and raise the screen.



Zip the screen down using the 2 side zippers.  
-Typical View



For convenience, the side of the screen has a  
magnet seal enabling access without  
unzipping the screen.  
-Typical View

*NOTE: DO NOT roll up the magnet with the  
screen- unzip both sides and roll up just  
the screen material. Damage may occur  
to the magnet strip if it is rolled up with  
the screen.*



## SECTION 8 – MAINTENANCE AND STORAGE

---

### SEALANTS – INSPECTION AND GENERAL INFORMATION

Water is a recreational vehicle's worst enemy when it is allowed to enter where it is not intended. Sealants perform a very important function and should be inspected closely and maintained regularly. Winnebago Industries® utilizes many different types of sealants. Refer to the "Sealants Call-Out Sheet" provided in your InfoCase for further information.

Sealants, in general, do not have "set" lifetimes. Varying environmental factors affect the pliability and adhesiveness of sealants. You or your dealer must:

- Inspect all sealants, a minimum of every six months.
- Inspect the moldings, windows, clearance lights, exterior compartment doors, and all their attachments.
- Also, inspect weather seals around entrance door, etc., and if necessary, have a dealer replace them immediately.
- Check for cracks, voids, gaps, breaks, adhesion, and any sign of physical deterioration.

*NOTE: Proper sealant inspection includes not just visual observation but running a finger along sealant seams to verify proper adhesion to the surface. Any loosened areas must be replaced.*

- Have the sealant replaced if you notice any of the above. Your local Winnebago Industries dealer has the correct and necessary parts and experience to help you maintain your sealants. See "Sealants Call-Out Sheet" provided in your InfoCase.
- Always use the same type sealant that was removed.
- Immediately have dealership check moldings, windows, and exterior attachments for leak source if you notice water inside of unit.

### NOTICE

Sealants must be inspected every 6 months and replaced if necessary.

### ROOF



### WARNING

STAY OFF ROOF. Surface may be slippery. Falling could result in death or serious injury.

For your safety, it is not recommended that you store or carry items on the roof.

Always have damage to the roof area repaired immediately. Damaged or detached sealant around the vents, air conditioner, body-to-roof seams, etc., should also receive immediate attention. Delaying these repairs may allow water leakage and result in damage to interior ceiling and body panels, upholstery, etc., which is not covered by the limited warranty (see "New Vehicle Limited Warranty" provided at the beginning of this manual).

### UNDERCARRIAGE

Buildup of mud and dirt under the body of the vehicle can cause damaging rust or corrosion on steel or aluminum parts and can add needless weight to the vehicle. This, in effect, reduces the amount of cargo you can carry and remain within GVWR and GAWR limits.

Corrosive materials, such as those used for ice and snow removal and dust control, can also accumulate on the underside of a vehicle. These materials should be removed by flushing the

undercarriage regularly with water, especially horizontal surfaces, cavities, and other areas where mud and other deposits may collect.

---

---

## **EXTERIOR AUTOMOTIVE PAINT FINISH**

The exterior finish of your motorhome is fully or partially finished with the highest quality automotive paint and clearcoat.

Follow these precautions to keep the finish looking its best and preserve maximum gloss and durability.

### **Parking**

- **Avoid parking under trees** – When this happens you should rinse the bird droppings and tree sap off as soon as possible. Tree sap is a form of sugar and will dissolve after a couple of rinses. Bird droppings can eat into a painted surface if left unattended and need removed as soon as possible. Lukewarm soapy water can help speed up the cleaning process.
- **Avoid parking near salt spray** – When this happens you need to rinse off the salt mineral residue to minimize the corrosiveness of the salt.
- **Avoid parking near factories with heavy smoke or industrial fallout** – Industrial fallout can eat into your exterior finish when dew or rain mixes with it to create nitric or sulfuric acid that gets magnified by the intensity of the sun. As the water evaporates, the acid becomes more powerful and attacks the painted surface.  
Rinsing and washing the surface helps remove the fallout and neutralize the acid. After the initial 60-day cure stage, a coat of wax or polish can help protect the surface from these types of contaminants.
- **Do not scrape ice or snow from the painted surface.** Brush off gently with a soft-bristled snow brush – avoid being forceful with the brush.  
If brush scratches show after the motorhome

thaws out, it may be possible to remove them by hand waxing with a silicone-free liquid wax.

- **Avoid covering painted surface.** When paint is covered (especially in outdoor conditions), water may appear between the cover and the motorhome due to rapid temperature fluctuations. The water may vaporize under certain conditions and migrate into the painted surface, possibly resulting in blisters and/or bubbles in the paint. These blisters/bubbles are not covered under warranty. Covering your motorhome is at owner's risk.

### **Driving**

- Rinse off bugs and bird droppings with water daily.
- Antifreeze, fuel, or windshield/window solution spilled on the painted surface should be rinsed off immediately with water and allowed to air dry. Wiping dry with a towel may create fine scratches due to the solvent nature of these types of fluids.
- Fuel cannot be diluted and dissipated with water. It must be removed with a mineral spirit type cleaner (such as *SEAFOAM Bugs-B-Gone*, or equivalent) or a silicone-free spray wax and microfiber cloth to remove the stain left by fuels.
- Ensure that all motorhome fluids (such as gas, oil, grease, antifreeze, transmission fluid, brake fluid, etc.) are completely wiped off of painted surfaces. Failure to comply may cause the paint to blister and/or peel.

*NOTE: When driving in wintry conditions, the road surface may be covered with heavy salts or small rocks to improve traction. These types of road conditions may cause surface damage to your motorhome. If possible, it is best to avoid these types of exposures. However, if you do use your motorhome under these types of conditions, you may want to consider, among other things, washing both the*

## SECTION 8 – MAINTENANCE AND STORAGE

---

*undercarriage and the body of your motorhome after exposure to these types of conditions.*

### Washing

- Commercial vehicle wash facilities should be strictly avoided! They will scratch your motorhome!

*Truck-style wash centers have high-pressure wands that emit higher than necessary water pressures and the brushes are very aggressive.*

*Most truck wash brushes are made from a heavy plastic for durability and are under heavy pressure. They are designed to clean heavy road films on semi trailers and are often dirty. They are not designed for custom painted motorhome's and they will scratch the clearcoat finish. Many times these scratches can penetrate the clearcoat finish, possibly causing delamination and/or other paint related issues that are not covered under warranty.*

- Wash your motorhome with cool or lukewarm water using a quality automotive detergent that does not contain bleach solution. Most auto stores offer car wash detailing soaps that are similar and do not have bleach in the formulation (such as Meguiars #62).
- Never use a bristled brush or broom to wash the painted surface. This will cause scratches in the finish. Using a microfiber cloth, mitt, or mop is strongly recommended.
- Be sure your cloth or applicator is clean. A dirty applicator can scratch your motorhome.

### Washing Procedure

- Rinse area to be washed with cold water to remove surface residue. Ensure you are not in direct sunlight.
- With area to be washed still wet from the rinse, use the recommended soapy mixture to clean the area. To avoid scratching painted surfaces, a microfiber cloth, mitt, or mop is strongly recommended to apply soapy water.

- Rinse washed area before soap evaporates.
- Dry the rinsed area before the water evaporates.

*NOTE: Avoid aiming water flow from a hose or spray from high-pressure washing equipment into any appliance intake, as damage or difficulty in operating appliances may occur.*

- After washing the motorhome, carefully inspect sealant around window frames, vents, and any other joints that may have loosened or separated. See “Sealants - Inspection and General Information” at the beginning of this section for details.

### Bug Removal

- Rinse any loose debris off with water and allow the remaining residues to soak and soften. Use soap and water to wash the residue, then rinse.

*NOTE: You may wish to repeat and leave soap on longer than normal to help with softening hardened residue.*

- For more stubborn areas, use an ammonia-based glass cleaner followed by washing with warm soapy water, then rinse.
- Remember to use microfiber towels during this process to help avoid scratches.
- If this does not work, as a last resort, use a bug removal product (like SEAFOAM Bugs-B-Gone, or equivalent) in a shady area and follow the directions on label. Ensure cleaner is completely wiped off of painted surfaces. Failure to comply may cause the paint to blister and/or peel.

### Polishing and/or Waxing

*NOTE: When your motorhome is new or has been repainted for any reason, no polish or wax should be applied to the finish until after a 60-day cure cycle at temperatures higher than 60 degrees for 60 days. Failure to observe this precaution could void your paint warranty.*

- We recommend a silicone-free polish with an orbital machine and terry cloth applicator.
- Liquid waxes are easier to apply and bring to a gloss with fewer residues.
- Avoid paste waxes. They sometimes have fillers and additives that give a very short term result. Stay away from silicones in polishes and soaps.
- Buffing compounds remove some of the mil film of the clearcoat, so we recommend that only professionals or very experienced users apply this type of product.

### **Inspection**

A motorhome exterior is subjected to many physical forces and environmental conditions. While the motorhome is parked, it is exposed to climate and weather extremes and other environmental conditions. While in operation, it is subjected to various twisting and flexing forces caused by routine cornering and turning, and by uneven road surfaces, such as bumps, potholes, railroad tracks, and parking lot entrances.

Inspect the exterior sidewall periodically for cracks which may represent a threat to the integrity of the sidewall.

Minute cracks in the surface (commonly referred to as "spider cracks" or "hairline cracks") caused by normal flexing of the fiberglass exterior are normal and typically pose no threat to the integrity of the motorhome other than appearance.

However, if a crack has opened up and the weave of the cloth is visible, this does represent a threat to the integrity of the fiberglass and must be repaired or covered as quickly as possible to avoid penetration by moisture, especially in freezing climates.

If the fiberglass has been damaged and contains cracks, tears, or holes, use plastic sheeting and duct tape, if necessary, to prevent moisture from damaging the sidewall material or the interior of the motorhome.

### **Protective Film**

#### **–If Equipped**

Your motorhome may be equipped with a protective film to defend against everyday road hazards. This film creates a barrier against bugs, road grime, bird droppings, and other harmful elements.

#### **Further Information**

See the manufacturer's information provided in your InfoCase for complete care and maintenance instructions.

---

---

### **EXTERIOR GRAPHIC CARE**

The pressure-sensitive graphics on your vehicle require very little maintenance. In order to allow the graphics to have the longest life possible, the following steps should be taken.

- Wash graphics with plain soap and water or any car wash detergent. Rinse thoroughly.
- High pressure water spray may loosen or damage graphics. Keep spray nozzle at least 1 1/2 feet from the edge of the graphics.
- Test any cleaning solution on a small section of graphic before using.
- Never use aromatic solvents such as acetone, M.E.K., toluene, paint thinner or lacquer thinner on graphics. Solvents may soften the vinyl and smear colors.
- Gasoline or other fuels spilled on graphics should be rinsed off immediately with water.
- Do not apply paint or clearcoat over the graphics.
- Do not apply wax over the graphics, especially wax containing petroleum distillates. Wax that has dried along the edge of a graphic can be removed with cotton swabs after softening it with isopropyl alcohol. Rinse area thoroughly after cleaning.

## SECTION 8 – MAINTENANCE AND STORAGE

---

---

---

### PLASTIC PARTS – CLEANING

Many parts in your vehicle, such as the dash, exterior light lenses, and certain exterior body panels are made of high-impact plastic materials that can be damaged by wiping with solvents or improper cleaning products.

Always try cleaning plastic parts with the mildest cleaners first and work your way up to stronger cleaning products. Use the following cautionary lists as a guide when selecting cleaning products to use on plastic parts.

#### NOTICE

Do not use citrus-based cleaners on polycarbonate finishes. Citric compounds will damage the high-gloss surface, causing it to appear dull or “flat”. Always test a cleaning product on a hidden area to be sure it will not cause damage to the appearance of the part.

Here is a list of mild cleaners that **may be used safely**:

- Car washing soap and water
- Glass cleaners *without ammonia*
- Mineral oil
- Multipurpose cleaners (such as Fantastik<sup>®</sup>, Formula 409<sup>®</sup>, etc.)

The following products, compounds, or solvents must be **wiped off immediately** to avoid damage:

- Ammonia
- Brake fluid
- Bathroom basin, tub, and tile cleaners
- Chlorine
- Ethyl alcohol
- Isopropyl (rubbing) alcohol
- Kerosene or gasoline
- Naphthalene
- Pine-type household cleaners

**Do not use** cleaners containing the following products, compounds, or solvents. These products **will damage** the finish.

- Acetic acid
- Acetone (nail polish remover)
- Aromatic solvents (lacquer thinners)
- Benzene
- Butyl alcohol

---

---

### EXTERIOR LIGHTS

Most Winnebago Industries<sup>®</sup> vehicles have polycarbonate lenses on exterior lamps, which are very sensitive to a variety of chemical solvents and cleaners.

Use only soap and water to clean exterior lamp lenses, especially headlights.

- Contact with certain chemicals can cause etching, “crazing” or cracking of the lens, which can significantly reduce the lens clarity and effectiveness of the lamp and may require replacement of the complete lamp housing.
- Some popular citric acid cleaners may cause polycarbonate lenses to become “hazy” or “foggy”.
- Do not use a pressure washer to clean headlights.
- Inspect and operate the lights regularly to confirm proper operation and mounting condition.

---

---

### INTERIOR SOFT GOODS

We recommend a weekly routine of vacuuming all fabrics and carpet throughout the motorhome to prevent an accumulation of dirt, which can detract from the appearance and shorten the life of carpet and fabrics.

#### Fabric Upholstery

Some fabrics used in this motorhome may contain fire retardant and lightfastness additives, which can be damaged by use of improper cleaning products. Some water-based household cleaning products are not formulated for use on fabrics and may cause excessive shrinkage or fading. Always test any cleaning product on a

hidden area of fabric before using on visible areas. For best results, fabric cleaning should be referred to a professional carpet and upholstery cleaner.

*NOTE: To minimize fading of upholstery, carpets and other interior fabrics caused by excessive sunlight, the drapes, blinds, or shades should be closed when the motorhome is parked for an extended period of time.*

 <b style="font-size: 1.2em; margin-left: 10px;">WARNING</b>
<p>When cleaning upholstery and fabric, do not use lacquer thinner, nail polish remover, laundry soaps, or bleach. Never use carbon tetrachloride, gasoline, or naphthalene for any cleaning purpose. These materials may cause damage to the material being cleaned and most are highly flammable, posing risk of injury due to fire.</p>

**Ultraleather™  
Leather-Like Upholstery**

Ultraleather synthetic leather fabric material has the luxurious look and feel of the finest European calfskin, with the durability and resistance to soils and stains of vinyl fabrics. It is also tougher than real calfskin and has superior resistance to punctures, snags, and rips.

For most soils and stains, the fabric manufacturer recommends spot treatment with a solution of water and Tide® brand laundry detergent or equivalent. More stubborn stains may be treated with a water-based multipurpose cleaner/degreaser such as Simple Green® or equivalent. Solvent cleaners such as nail polish remover or other aromatic solvents are not recommended.

**Care Instructions**

- Spot clean with mild soap and water.
- Air dry or, if desired, dry quickly using a hair dryer on warm setting - not hot.

- For stubborn stains, use cleaner-degreaser.

<b>UltraLeather Cleaning Chart</b>		
<b>Type of Stain</b>	<b>Detergent/ Water</b>	<b>Cleaner/ Degreaser</b>
Coffee, Tea	◆	
Red Wine, Liquor	◆	
Cola, Soft Drinks	◆	
Milk	◆	
Ketchup	◆	
Steak/Soy Sauce	◆	
Mayonnaise, Butter	◆	◆
Salad Oil	◆	◆
Chocolate	◆	◆
Cosmetic Makeup	◆	◆
Lipstick	◆	◆
Face Cream	◆	◆
Suntan Oil/Lotion	◆	◆
Shoe Polish	◆	◆
Urine	◆	◆
Machine Oil		◆

**Vinyl Fabrics (including ceiling)**

Vinyl should be cleaned with a soft, damp cloth, and a mild detergent only. Do not use solvents. Solvents may damage the surface of the vinyl.

**Draperies, Curtains, and  
Bedspreads**

These items may be woven from a variety of fabrics. We recommend that these be professionally dry cleaned only. A five percent shrinkage may occur when you have these items dry cleaned.

**General Stains**

As with any stain or contamination, the quick response is the best, especially when done in conjunction with the proper cleaner for the type of stain.

---

**CABINETRY – CLEANING**

Wooden items may be cleaned with a soft cloth and a good quality wood finish cleaning product.

## SECTION 8 – MAINTENANCE AND STORAGE

---

Vinyl simulated wood panels may be cleaned with a mild, water-based cleaner and a soft cloth. Do not use solvents on vinyl wood panels.

*NOTE: Many cabinetry and furniture items throughout this motorhome are constructed either partially or completely of real hardwoods. Because of natural variations in woodgrain density, slight differences in stain hue may exist between one item and another. This is the distinctive character and beauty of real wood.*

---

---

### DECORATIVE VINYL WALL PANELING – CLEANING

Decorative Vinyl Wall Paneling may be cleaned with mild detergent and warm water. The soap product should contain no abrasives, and the use of a soft cloth or sponge with the cleaning liquid should help preserve the finish of the vinyl.

Do not use bleach, cleaning agents with solvents or harsh chemicals, oil based spray cleaners, or other multipurpose cleaners such as Fantastik® or Formula 409® as they could damage the vinyl surface.

---

---

### TABLES AND COUNTERTOPS

Work surfaces are covered with a plastic or thermo-formed laminate that resists solvents, stains, and abrasions. A coat of furniture wax applied to these surfaces on the counters and table will help preserve their beauty and make cleaning easier. Always clean the surface before applying wax.

---

---

### SINK – STAINLESS STEEL

#### Care and Cleaning Instructions

The stainless steel sink can usually be cleaned with water and soap or detergent using a soft cloth or sponge.

- **Rinse thoroughly** with warm water and wipe dry quickly to avoid spots and streaks.

- **For stubborn stains**, use a mild abrasive cleanser like Soft Scrub®, Comet®, etc. Work in the direction of the “grain” of the brushed finish lines.
- **Never use steel wool.** Particles of steel from the wool pad can embed into the sink surface, then become rusty and unsightly.
- **Avoid contact with full-strength** bleaches, household chemicals, and acid-based cleaners. If this happens, rinse and wipe dry quickly.
- **Salt, mustard, and mayonnaise** can cause pitting if left on the steel sink surface. If spilled, clean and rinse immediately.
- **A high iron content** in the water (hard water) may result in a brown or rust-colored stained appearance. If noticed, dry towel sink after each use.
- **Do not use rubber mats** in the sink bowl. Material trapped under mats can complicate cleaning.

*NOTE: Improper use may damage this product and void the warranty.*

---

---

### RANGE AND REFRIGERATOR

For care and appearance maintenance of the range and refrigerator, refer to the appliance manufacturer’s operation and maintenance manuals included in your InfoCase.

---

---

### VINYL FLOORING

#### Care and Maintenance

You can easily maintain the beauty of your vinyl flooring with little effort, by following these recommendations:

- Sweep or vacuum floor daily (use a vacuum without a beater bar head.) Remove loose dirt with a soft brush or Swiffer® type product.
- For more intense cleaning, use a non-abrasive cleanser, such as Mr. Clean®. Rinse with clean water.

*NOTE: Floor cleaners containing waxes, brighteners, or gloss agents are not recommended.*

- Regular cleaning with solvent-based chemicals may adversely affect the topcoat performance.
- Do not use undiluted bleach or leave a dilution of bleach on the floor for longer than one hour.
- Vinyl flooring is extremely durable and long lasting. It is normal for the floor to show some denting and dimpling where furniture sets due to the soft nature of the material. The dents are not permanent and will come out over time.

### **Maintenance Tips**

- Install protection (such as pads or casters) on furniture with legs or sharp edges. This protection should not contain bitumen, which may cause brown stains.

*NOTE: Faulty pads and casters should be removed and replaced.*

- Burning cigarettes and matches can cause damage to the flooring.
- Use doormats (that do not contain bitumen) to keep out most of the dirt and dust.
- Remove spills immediately with a damp cloth, followed by rinsing with clean water.
- The use of stiletto heels is not recommended, as they may cause permanent damage to the flooring.
- Protect flooring from prolonged direct sunlight exposure.

### **Treatment of Stains**

**Acids, alkali, alcoholic beverages, coffee, soft drinks, ketchup, fruit, fruit juices, food, vegetables, mustard, ink, and iodine:**

- Remove the stain with lukewarm water and a cloth or sponge. If necessary, clean with a soft nylon pad and non-abrasive mild detergent or resilient floor cleaner.

#### **Heel marks:**

- Clean as soon as possible with a soft nylon pad and non-abrasive mild detergent or resilient floor cleaner.

**Asphalt, candle grease, chewing gum, fat, oil, tar, and shoe polish:**

- Gently remove with a blunt instrument and treat with a soft nylon pad and non-abrasive floor cleaner.

**Lacquer and nail polish:**

- Remove as soon as possible. Do not allow to dry. If necessary, apply nail polish thinner (sparingly) to remove any residue.

**Corrosion, paint, and grass stains:**

- Treat as soon as possible with a soft nylon pad and non-abrasive mild detergent or resilient floor cleaner.

**Varnish, oil paint, and solvents:**

- Blot up as soon as possible. Do not rub, as this will only spread material further across the surface. Carefully treat with a mild cleanser. When dry, carefully peel the stain off. MEK may be used sparingly, if necessary. Rinse immediately with clean water.

**Pet stains:**

- Treat with lukewarm water. If stain remains visible, clean with a soft nylon pad and non-abrasive resilient floor cleaner.

---

---

## **BATHROOM**

### **Toilet**

For instructions on the care of your toilet, refer to the information in your InfoCase.

### **Tub and Shower Walls**

The tub and shower walls in the bathroom should be cleaned with mild soap and warm water. Do not use an abrasive cleaner on the shower walls and tub, as scratching and discoloration may occur. Stubborn stains may be removed with an automotive-type cleanser.

---

---

## **WINDOWS**

Windows may be periodically cleaned with a good quality glass cleaner or mild soap solution using a soft cloth. Using chemicals, solvents, or abrasive cleaners on acrylic windows could damage the window surface.

## SECTION 8 – MAINTENANCE AND STORAGE

---

For Acrylic Windows:

### NOTICE

Do not use an ice scraper on acrylic windows. Damage to the windows may occur.

**For Glass Windows:** Use care when removing ice or frost from the windows. Always use a plastic ice scraper, never one made of metal.

---

## DOORS AND MIRRORS

### Entry door latches

- Inspect the entry door latches regularly for signs of wear and tear.
- Ensure the latches are functioning smoothly and securely.
- Door locks and hinges should be lubed periodically with dry lubricant to ensure trouble-free operation and to protect against freeze-up.
- Replace any damaged or faulty latches immediately to ensure safety.

### Cargo Door Compartments

- Check the cargo door compartments for any signs of damage or malfunction.
- Verify the compartments close securely and latch properly.
- Clean and lubricate the hinges and latches with dry lubricant to prevent rust and ensure smooth operation.
- Inspect the seals around the compartments to prevent water leaks and maintain the integrity of the storage areas.

### Mirrors

Use care when removing ice from the mirrors to protect the reflective surfaces.

---

## VEHICLE STORAGE – PREPARATION

Properly preparing your vehicle for storage will lessen the possibility of damage to your vehicle. Prepare the motorhome for vacancy just as you would if you were leaving your house for an extended period.

### Clean and Prep Coach for Storage

1. Turn the furnace thermostat switch OFF.
2. **Remove all foods and items that may cause odors from cabinets and refrigerator.**
3. Clean and defrost the refrigerator. Prop the door open slightly to allow any odors to dissipate. Place an open box of baking soda inside the refrigerator to help absorb odors.
4. **Battery instructions:**
  - The battery must be stored in dry and well-ventilated environment. If the storage temperature is too high or too low, this will affect the self-discharge rate of the battery and accelerate the natural aging of the battery. It is therefore recommended to store the battery at a temperature of 20-45°C (68°F-113°F) and stay away from water sources, heat sources, and metal objects.
  - If the battery is not going to be used for a long period of time, it is recommended to be stored intact in a semi- charged state (60% SOC). The battery is recommended to be discharged to 30% and then recharged to 60% every three months.
  - For safety reasons, the battery must not be stored at temperature above 45°C (113°F) or below 20°C (68°F).
  - When the temperature of battery is equal to or below -20°C (-4°F), the battery cannot be used for charging, discharging or heating.
  - To extend the service life of the battery, the battery is recommended to be used at 20°C (68°F) to 45°C (113°F).

- If the battery level is below 1% after use, it should be charged to 60% before storage. If the battery is left idle for a long period of time with critically low SOC, irreversible damage to the battery cell will occur, reducing the service life of the battery.
- If the battery SOC is critically low and being left idle for too long, it will enter deep sleep mode and will need to be recharged before it can be used again.

*NOTE: We do not recommend leaving the shoreline plugged in continuously during storage.*

*NOTE: See the EcoFlow battery supplement located in your supplement manual for additional information.*

5. Have the vehicle chassis completely serviced and lubricated. Be sure radiator antifreeze protection level is sufficient for the lowest anticipated temperatures.
6. Wash and wax the coach.
7. Inspect all seams and seals around doors, windows, vents, and any other joints. Replace or repair any that are damaged. Sealing materials and compounds can be purchased from your dealer. Badly damaged weather seals may need to be replaced by your dealer.
8. Close all windows and roof vents. Protect all appliance vent openings from contamination by animals or insects (e.g. bird nest, wasp nests, etc.)
9. Lubricate all door hinges and locks.
10. Clean the interior of the coach. Dirt and stains are more easily removed when fresh.
11. Follow “Vehicle - Leaving in Storage” suggestion in chassis owner’s manual included in your InfoCase.

If you are storing your vehicle through the winter, or in cold climates, extra preparations must be made to protect equipment and systems that can be damaged by freezing temperatures. See “Winterizing Procedure” in *Section 6 - Plumbing*.

---

---

## **CHASSIS SERVICE AND MAINTENANCE**

Consult the appropriate sections in the chassis manual for specific information regarding operating safety, service recommendations, and maintenance schedules for the chassis section of your vehicle.

---

---

## **VEHICLE STORAGE – REMOVAL**

1. Completely air out the motorhome.
  2. Check window operation.
  3. Check cabinet and door hinges. Lubricate with penetrating oil, if necessary.
  4. Close all faucets and drain valves that are open.
  5. Add a few gallons of water to the fresh water tank and turn on the water pump to check for leaks, especially at fittings.
  6. Open all faucets in turn to release trapped air and check to be sure faucet washers have not hardened during storage.
  7. Sanitize the water system as outlined under *Disinfecting the Fresh Water System* in the Plumbing section, then flush the waterlines thoroughly with fresh water.
  8. After flushing fresh waterlines, install a new water filter cartridge on the galley sink water filter and/or full-coach water filtration system (if equipped). See appropriate filter installation instructions in Plumbing section.
- NOTE: Always purge a new filter with clean running water before using. See filter manufacturer’s directions included with the filter cartridge.*
9. Check the toilet for proper operation.
  10. Add water to the holding tank using the galley sink faucet. Check to be sure dump valves seal tightly.
  11. Check around all appliances for obstructions and ensure that all vent openings are clear.
  12. Start refrigerator and check for proper cooling.

## SECTION 8 – MAINTENANCE AND STORAGE

---

13. Clean wall and counter surfaces.
14. Replace batteries, if necessary, and check out electrical system to make sure all lights and electrical components operate.
15. Check tires for proper cold inflation pressure. See “Vehicle Certification Label” in *Section 1 - Introduction*. See “Valve Stem Access” in *Section 3 - Driving Your Motorhome*.
16. After washing accumulated winter grime from the vehicle, it is important to carefully inspect the seams and sealants for separation or cracks that may have appeared around the window frames, vents, and any other joints. See *Sealants – Inspection and General Information* at the beginning of this section. Resealing is quite simple and the material is quickly and easily applied. Appropriate compounds are available from your dealer. See the *Sealants – Recommended Application* page in the Supplement Manual provided in your InfoCase.  
Also inspect weather seals around doors, etc., and if necessary, have a dealer replace immediately.

**SECTION 8 –  
MAINTENANCE AND STORAGE**

**MOTORHOME MAINTENANCE CHART**

These recommendations apply for normal recreational use. Heavy duty or full-time use may require more frequent maintenance intervals.

Always use specified sections or manufacturer's guide for further information and instructions.	Before Each Use	Weekly	Monthly	Every 3 Months	Every 6 Months	Every Year	As Necessary
<b>Electrical System</b>							
Check battery condition meter	◆						
Check battery connections			◆				
Check 12V fuses and 120V breakers							◆
Check GFCI receptacles			◆				
<b>Plumbing System</b>							
Sanitize plumbing system							◆
Winterize plumbing system							◆
Clean water pump strainer filter						◆	◆
<b>Exterior</b>							
Clean roof				◆			◆
Clean sidewalls			◆				◆
Clean windows							◆
Flush underside of vehicle				◆			◆
<b>Safety Equipment</b>							
Check operation of the following items:							
Headlights, Taillights, and Marker Lights	◆		◆				
Turn Signals	◆		◆				
Horn	◆		◆				
Hazard Warning Flashers	◆		◆				
Windshield Wipers and Washers	◆		◆				
Headlight Alignment							◆
Fire Extinguisher - check charge indicator	◆		◆				
Smoke Alarm - test operation *	◆		◆				
Carbon Monoxide Alarm - test operation *	◆		◆				
Propane Gas Leak Detector - test operation	◆		◆				
(*replace battery if needed)							

## SECTION 8 – MAINTENANCE AND STORAGE

### MOTORHOME MAINTENANCE CHART

These recommendations apply for normal recreational use. Heavy duty or full-time use may require more frequent maintenance intervals.

Always use specified sections or manufacturer's guide for further information and instructions.	Before Each Use	Weekly	Monthly	Every 3 Months	Every 6 Months	Every Year	As Necessary
<b>Appliances</b>							
<b>Water Heater</b>							
See water heater system manufacturer's maintenance guide							◆
Inspect and clean exterior vent	◆						◆
<b>Refrigerator</b>							
See refrigerator manufacturer's maintenance guide							◆
Inspect and clean exterior vent/drip tray drain tube	◆						
<b>Furnace</b>							
See furnace manufacturer's maintenance guide							◆
Inspect and clean exterior vent	◆						
<b>Air Conditioner</b>							
See A/C manufacturer's maintenance guide							◆
Inspect for exterior damage				◆			◆
Check and clean filter			◆				
<b>Range Top</b>							
See range manufacturer's maintenance guide							◆
Inspect and clean/replace range hood grease filter							◆
<b>Sealants</b>							
Inspect (see "Sealants" at the beginning of this section for proper inspection technique)					◆		◆
Replace (see "Sealant Call-out Sheet in the supplement manual provided in your InfoCase)							◆
<b>Frame and Chassis</b>							
Follow chassis manufacturer's maintenance guide (refer to chassis manual)							◆
Inspect hitch receiver (if towing)	◆						

**SECTION 8 –  
MAINTENANCE AND STORAGE**

**MOTORHOME MAINTENANCE CHART**

These recommendations apply for normal recreational use. Heavy duty or full-time use may require more frequent maintenance intervals.

Always use specified sections or manufacturer's guide for further information and instructions.	Before Each Use	Weekly	Monthly	Every 3 Months	Every 6 Months	Every Year	As Necessary
<b>Tires</b>							
Check and adjust air pressure	◆						◆
Check tread wear	◆						◆
Check front end alignment and adjust if needed							◆
<b>Miscellaneous</b>							
Lubricate locks, hinges, latches			◆				◆
Inspect entry door latches and seals			◆				
Ensure all doors are fully latched before use	◆						

# SECTION 9 – MISCELLANEOUS

---

---

---

## LOADING THE VEHICLE

*NOTE: Your motorhome's load capacity is designated by weight, not by volume, so you cannot necessarily use all available space when loading your motorhome.*

- Store or secure all loose items inside the motorhome before traveling. Possible overlooked items such as canned goods or small appliances on the countertop, cooking pans on the range, or free-standing furniture items can become dangerous projectiles during a sudden stop or evasive maneuver.
- Be aware of GVWR, GAWR, and individual load limit on each tire or set of duals.

When loading the vehicle, distribute the cargo load equally so that you do not exceed either the Front or Rear Gross Axle Weight Rating (GAWR) or the Gross Vehicle Weight Rating (GVWR). The Gross Axle Weight Rating (GAWR) means the weight value specified by the chassis manufacturer as the load carrying capacity of a single axle system as measured at the tire-to-ground interfaces. This is the total weight a given axle is capable of carrying. Each axle has its own rating.

Have your vehicle weighed to determine the proper load distribution for your vehicle. Also distribute cargo side-to-side so the weight on each tire or dual set does not exceed one half of the GAWR for either axle.

For example, if the Front GAWR is 6,000 lbs., there should be no more than 3,000 lbs. on each tire. (If the left side weighs 3,100 lbs. and the right side weighs 2,700 lbs., at least 100 lbs. of the load must be shifted from the left side to the right side.) The GVWR is listed on the Vehicle Certification Label. (See sample in *Section 1 - Introduction*).

The GCWR (Gross Combination Weight Rating) means the maximum allowable loaded weight of this motorhome and any towed trailer or towed vehicle.

*NOTE: We recommend that you dump all holding tanks before traveling to avoid carrying unnecessary weight.*



---

---

## WEIGHING YOUR LOADED VEHICLE

To check the weight of your fully loaded motorhome, locate a commercial weighing scale that is capable of weighing large trucks.

*NOTE: Sales literature may give approximate or standard weights. Your actual motorhome weight may differ based on added factory and/or dealer options.*

### Loading

Load your vehicle completely as if you were going on a long trip with everything you would carry, including food, clothing, bedding, lawn chairs, etc., a full fuel tank, full propane tank, and a partial tank of fresh water, but empty holding tanks. Remember, tongue weight must be included in the GVWR.

### Finding a Scale

In urban areas, the most common places to find a public access scale are commercial truck stops. In rural areas, most grain storage elevators have scales available. Most scales charge a nominal fee for weighing a vehicle.

## SECTION 9 – MISCELLANEOUS

### Weighing

There is typically a scale operator to direct you, but the basic routine is to take three separate weights - front axle, whole vehicle, and rear axle.

You will first drive only your front wheels onto the scale pad, then drive ahead so that the whole vehicle is on the scale, then finally pull off until just the rear wheels are on the pad.

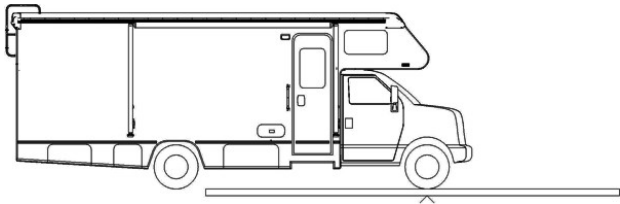

Front GAWR (Front Axle Only)

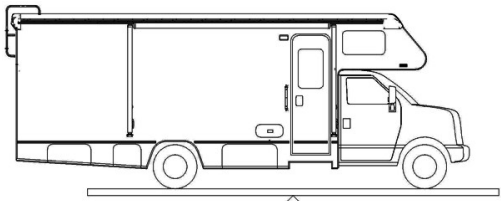

GVWR - Whole Vehicle (All Axles)

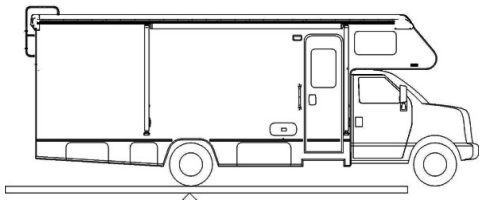

Rear GAWR (Rear Axle Only)

You will receive a weight “ticket” that states your current Front Gross Axle Weight, Rear Gross Axle Weight, and Gross Vehicle Weight. You can compare these weights to the weight ratings listed on your Vehicle Certification Label to use as a guideline for future loading limits and weight distribution.

The gross weight of the vehicle must not exceed the Gross Vehicle Weight Rating (GVWR) specified on the Vehicle Certification Label. The front and rear axle weight also should

not exceed the corresponding Axle Weight Rating specified on the Vehicle Certification Label.

### Corner Weighing (Side-to-Side)

The most accurate method of weighing a motorhome is to weigh each “corner” of the motorhome separately (single L/R front wheels or L/R rear dual sets.) This method will help you determine how to distribute your cargo to avoid overloading, especially on tires.

To determine the weight distribution on each tire or dual set, you will need to find a scale capable weighing side-to-side, or all four “corners” of the vehicle separately.

A truck scale may be used if the ground is level with the scale surface and the scale has clearance to drive one side of the motorhome onto the scale as shown.

Drive the motorhome on the level area next to the scale and straddle the scale so that only one side of the motorhome will be on the scale pad.

*NOTE: Wind and precipitation can also cause weight inaccuracies.*

Pull only the right front wheel onto the scale pad as shown.

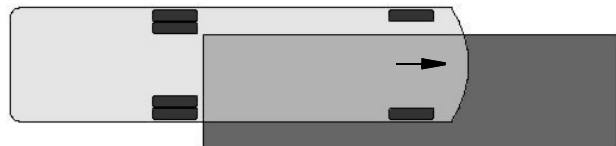

Weighing Right Front Corner

When the front wheel has been weighed, pull the motorhome straight ahead until only the right rear wheel/dual set is on the scale pad as shown.



Weighing Right Rear Corner

Now, turn the motorhome around and repeat the process for the other side.

The load on each wheel or dual-wheel set should not exceed one-half of the corresponding GAWR. For example, if the GAWR for the rear axle is 12,000 lbs., then the load on each rear dual set (left rear duals or right rear duals) should not exceed 6,000 lbs.

Tires must be filled to the recommended air pressure for the highest loaded tire set on that axle. For example, on the rear axle, if the left side weighs more than the right, fill the left tires to the pressure required for that weight, then fill the right tires to the same pressure as the left ones. See “Valve Stem Access” in *Section 3 - Driving Your Motorhome*.

If your actual weight is considerably less than GAWR, you may be able to lower your tire pressure. See a tire dealer for a load/pressure chart.

*NOTE: The Hitch Load from a Towed Vehicle or carrier box must also be counted on the Rear GAWR and subtracted from the rear axle cargo capacity.*

Be aware that hitch load can affect handling characteristics. The more weight on the hitch, the lighter the front end will feel at the steering wheel.

---

---

## **CAR OR TRAILER TOWING**

### **Hitch Capacity\***

**5,000 lbs. max.**

### **Tongue Weight\***

**500 lbs. max.**

The factory installed towing hitch on this motorhome is capable of pulling 5,000 lbs. load (max.), however, the vertical (tongue) weight may vary according to chassis and model combinations (\*see label on hitch). Towing capacity may be less than hitch rating.

When towing a trailer or vehicle, do not exceed either the GVWR, the rear axle GAWR, or the chassis GCWR (the combined loaded weight of the motorhome and the towed vehicle).

*See preceding items “Loading the Vehicle” and “Weighing Your Loaded Vehicle” for explanation of weight ratings.*

Because of individual vehicle use and loading habits, we recommend weighing the vehicle while fully loaded to avoid exceeding any of the listed Gross Weight Ratings. See “Vehicle Certification Label” in the Introduction section for information on gross weight ratings.

Towing will affect vehicle handling, durability, and fuel economy. Exceeding any of the listed Gross Weight Ratings will result in unacceptable overall vehicle performance. Maximum safety and satisfaction when towing depends on proper use of correct equipment.

When towing a vehicle behind your motorhome, the tow bar should be level or pointing slightly upward towards the tow vehicle.

When coupling the vehicle tow bar to the Factory Receiver Hitch using a “drop receiver” or a conventional “ball mount” (commonly referred to as a “stinger” or a “draw bar”), do not exceed a 4” drop, nor one that the centerline of the hitch pin to the centerline of the ball exceeds 8”. See the following Hitch Assembly illustration.

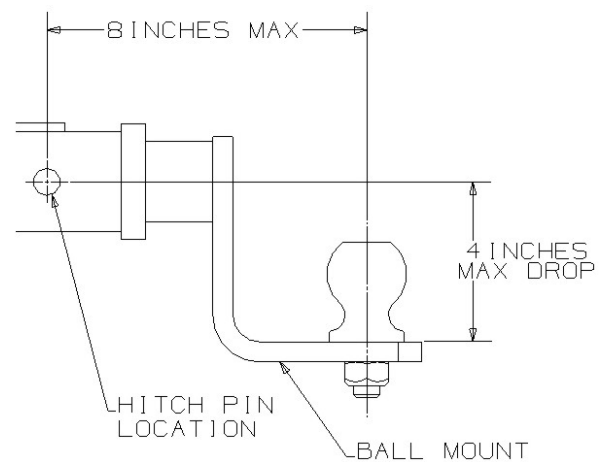

**Hitch Assembly**

If a towing “brake system” is required, we recommend that a “modulated” towed vehicle braking device be installed. This means that when the motorhome brakes are applied, whether hard or soft, a mirror effect occurs in the braking of the towed vehicle. In other words, the more

## SECTION 9 – MISCELLANEOUS

force applied to the motorhome brakes, the more force will be applied to the rear vehicle's braking system.

We do not recommend the usage of a “surge-style” braking device. The usage of a surge brake (especially when coupled with a hitch ball located outside our recommended limits) places excessive stress on the hitch. This abuse of the ball mount and the hitch may cause premature hitch assembly failure.

Finally, do not forget to consider the actual tongue weight. This should not exceed the stated hitch vertical load for your vehicle. This weight is typically defined as the tongue weight of a towed vehicle hitch, boat trailer tongue weight, or a receiver-mounted carrier rack.

Check state regulations on trailer weight and trailer brake requirements to be sure you select the right equipment before towing.

Before descending a steep or long grade when towing a trailer, reduce speed and shift into a lower gear to control vehicle speed. Avoid prolonged or frequent application of brakes which could cause overheating and brake failure.



### WARNING

For safe towing and vehicle handling, maintain proper trailer weight distribution. The total weight of the motorhome and the vehicle towed must not exceed the Gross Combined Vehicle Weight rating. See the “Body and Chassis Specification” chart in the Introduction section.

### NOTICE

Exceeding any of the recommended gross vehicle weight ratings may result in vehicle damage. Do not install a frame equalizing-type hitch on your vehicle.

## TRAILER WIRING CONNECTOR

Your motorhome is pre-wired for trailer or car towing lights with a 7-pin socket.

The following diagram shows proper connection of trailer or tow vehicle wiring to the motorhome light system. The “pigtail” assembly with the (car/trailer end) connector plug should be wired by a qualified technician.

The trailer brake controller connector is located beneath the driver seat.

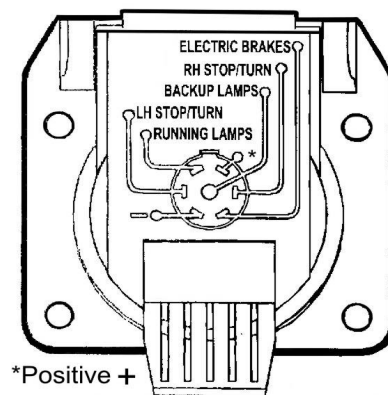

## TOWING GUIDELINES

### Gross Vehicle Weight Rating (GVWR)

This is the maximum allowable weight of the fully loaded vehicle. Included are fuel, water, LP, passengers, cargo, tools, and optional equipment installed by the motorhome manufacturer, dealer, or owner. This value is found on the VIN label, typically placed near the driver position.

### Gross Axle Weight Rating (GAWR)

This is the total weight a given axle is capable of carrying, measured at the ground. Each axle has its own rating. These values are also found on the Vehicle Certification Label: front and rear.

### Gross Combination Weight Rating (GCWR)

This is the maximum allowable weight of the motorhome and loaded trailer, including the items noted in GVWR above. For purposes of

this definition, the “trailer” can be a trailer, a vehicle towed on a dolly, or a vehicle towed by means of a tow bar. GCWR is typically specified based on durability and performance of the tow vehicle drive train: engine and cooling systems, transmission, drive line, drive axle, and others. The tow vehicle brakes may be rated for operation at GVWR, not GCWR.

*NOTE: State or provincial laws/regulations may require the “trailer” to be equipped with brakes that are activated when the motorhome brakes are applied. The user is responsible to know and understand the laws of the state or province being traveled. The Department of Transportation in a given state or province should be able to provide specific information.*

## Hitch Ratings

SAE Standard J684 defines:

- Class 1 trailers as “GVWR not to exceed 2,000 lbs”.
- Class 2 trailers as “GVWR over 2,000 lbs. and not to exceed 3,500 lbs. GVWR”.
- Class 3 trailers as “GVWR over 3,500 lbs. and not to exceed 5,000 lbs. GVWR”.
- Class 4 trailers as “GVWR over 5,000 lbs. and not to exceed 10,000 lbs. GVWR”.

Hitches are to be permanently marked with “Maximum trailer GVWR to be drawn” and “Maximum vertical tongue weight to be imposed.” The SAE standard does not specify a vertical load rating.

Traditionally, hitches are labeled 3,500/350 as Class 2, 5,000/500 as Class 3, and 10,000/1,000 as Class 4. The vertical tongue load value of 10 percent of drawn rating comes from the collective experience that 10 percent is the minimum value that provides stable towing of a trailer.

*NOTE: Some Winnebago Industries® models equipped with a Class 3 hitch may have a label limiting vertical tongue load to 350 lbs. Some Winnebago Industries models equipped with a Class IV hitch have a*

*label limiting vertical tongue load to 500 lbs. On a 228" wheelbase, a 500-lb. load on a hitch 11' from the rear axle will apply about 800 lbs. at the axle.*

The user must verify that the hitch equipment being used is adequate for the application.

---

---

## WINDOWS

**(Typical View – Your motorhome may differ in appearance)**

*NOTE: The windows must be closed and latched during transit. They are not designed to be open while the vehicle is in motion.*

### Push-Out Windows

The bedroom and lounge windows are secured by safety latches at the sides and bottoms of each window.

To open window, release all window latches and push open.

1. Side Latches - Pull down toward bottom of window frame.
2. Bottom Latches - Pull toward the left-hand side of the window frame.
3. Push window open.

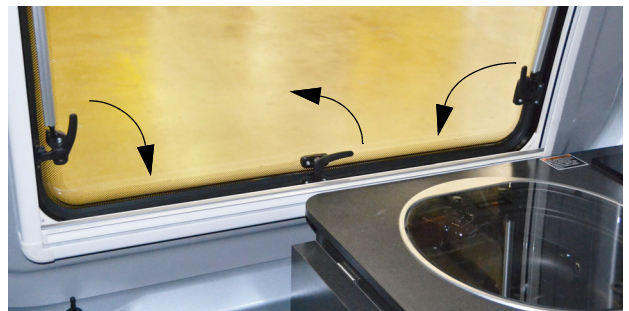

-Typical View

### Propping the Windows Open

The bedroom and lounge windows are featured with prop rods on each side of the window. These rods have three notches to prop your windows open at. Push window open slowly and stop at the preferred notch setting.

## SECTION 9 – MISCELLANEOUS

### Closing the Windows

To close window, extend all the way out (past the third notch setting) and the window will retract. Grab one of the window latches and pull window toward you and secure all four latches into locked position.

---

---

### POWER ROOF VENTILATOR (BATH)

Fan Lift Bar



Fan Power Switch

Power Roof Ventilator

### To Operate Ceiling Ventilator

1. To open the ventilator dome, push upwards on the Fan Lift Bar.
2. Press the Fan Power Switch to operate.
3. When finished using the roof ventilator, press the Fan Power Switch to stop operation.
4. Pull the Fan Lift Bar down to close dome.

---

---

### POWER ROOF VENTILATOR

The Power Roof Ventilator features a rain cover, electric lift, and thermostat operation with exhaust airflow.

The vent is controlled by a switch on the wall, remote, or keypad controls on the fan.

*NOTE: In event of power failure, the ventilator dome may be opened or closed manually using the Dome Crank knob.*

Dome Crank

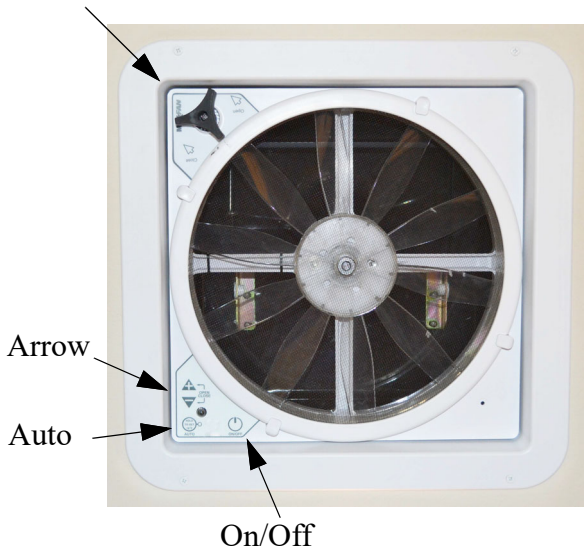

Power Roof Ventilator

- **ON/OFF** – Press to turn the fan on or off. The vent lid will open automatically when the fan is turned on and close when the fan is turned off.
- **AUTO** – Press to enter Auto Mode. You will hear three (3) quick beeps to confirm the fan is in Auto Mode. To exit Auto Mode, press the On/Off button.
- **ARROW** – In Auto Mode press the +/- arrow buttons to adjust thermostat temperature up or down. Press the +/- arrow buttons at the same time to open or close the vent lid.

*NOTE: For best results, close all other roof vents, windows, and doors, then open one (1) window the farthest distance from the roof ventilator. The fan speed selector allows you to control the amount of circulation you need at any time.*

### Further Information

See the power ventilator manufacturer's operating instructions supplied in your InfoCase for further instructions, care, and cleaning information.

## **AWNING – POWER WITH BLUETOOTH**

The Power Awning switch and Awning Light switch is located near the sliding entrance door.

*NOTE: Make sure the awning is fully retracted before driving the vehicle.*



Power Awning Switches and Awning Light Switch  
(Located near sliding entrance door)  
-Typical View

CAUTION

Pinch Hazard. Ensure there are no people who could be harmed or objects that can be damaged. Failure to heed this warning could result in severe injury and/or property damage.

### **Operating the Awning**

- Press the Patio Awning switch OUT (to extend) or IN (to retract).

### **Ignition Lockout System**

The ignition lockout system will disable the extend function while the vehicle ignition key is in the On position. With this feature, the Awning will only extend when the vehicle ignition key is in the Off position. The Awning can retract anytime regardless of the ignition key position.

### **Bluetooth Feature**

The awning is equipped with a bluetooth feature that allows the user to extend and retract the awning. The app can be downloaded to your smart-phone via the appstore.

### **Awning Motion Sensor**

The awning has a wind motion sensor that is powered by batteries. When the batteries die, there will be a beeping sound inside the coach indicating the need to replace them. The batteries are located in the lead rail on the motor side of the awning.

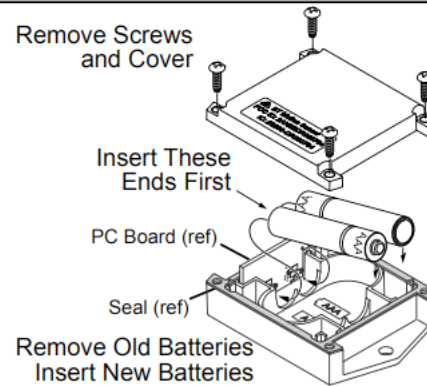
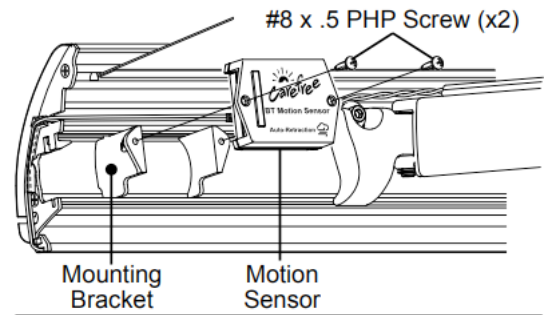

Awning motion sensor battery replacement  
(see below for details).  
-Typical View

To replace the batteries:

1. Remove the screws and the rear cover from the module.
2. Remove the two batteries.
3. Make sure that the contact tabs are clean and bent out for best contact.
4. Insert new batteries. Match the new battery orientation with the old batteries.

## SECTION 9 – MISCELLANEOUS

Tip: Place the battery end next to the PC board first then swivel the other end into the case. This will set the batteries firmly into the case.

5. Check that the seal is in place and flat, and then attach the rear cover with the screws removed previously.

6. To Test: Hold the sensor vertically with the Carefree logo upright, repeatedly move the sensor vertically up and down to simulate a brisk wind. The awning should retract. If the awning does not retract, it may be necessary to pair the sensor to the BT12 Module. Follow the steps below.

7. After the module works correctly, install the module on the bracket.

*NOTE: Bracket will be unattached in the lead rail. When the module is screwed onto the bracket it will tighten and bind in the lead rail.*

Pairing the motion sensor may be necessary for replacements and upgrades, the steps are as follows:

1. Extend the awning using the switches.
2. Place the awning in pairing mode.
3. Insert the batteries into the module.
4. Hold the motion sensor next to the control module. The device should pair within 90 seconds.

5. To Test: Hold the sensor vertically with the Carefree logo upright, repeatedly move the sensor vertically up and down to simulate a brisk wind. The awning should retract.

6. Mount the module.

### Further Information

For complete operating instructions, features, safety precautions, and maintenance care, refer to the Awning manufacturer's user guide provided in your InfoCase.

## LADDER –If Equipped

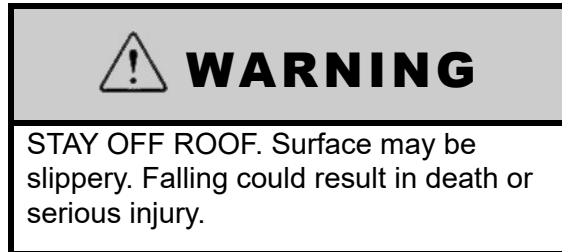

Your motorhome may be supplied with a Ladder mounted on the rear passenger side door.

The ladder on your motorhome is provided for limited access to the roof. The ladder must be removed from the stored position and mounted on the roof rail for use.

Walking or working on the roof should be left up to qualified service personnel using proper safety equipment in a safe environment. You should only walk or work on the roof if you are qualified and have created a safe environment.

For your safety, it is not recommend that you store or carry items on the roof.

### Before Using the Ladder

- **Inspect the ladder** to make sure it is not damaged. Never use a damaged ladder.
- **Keep the rungs of the ladder clean and dry** while in use. Never use the ladder when it is raining, snowing or icy. The rungs can become slippery. Do not step onto the rungs if the rungs are wet, or if your shoes are wet or carry mud or debris that could result in a loss of footing.
- **Never ignore warning labels** or weight limits defined on your ladder. The following warning label is located on or near the ladder:

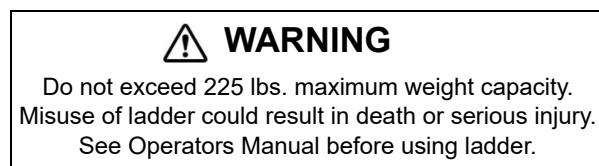

- **Maximum Capacity: 225 lbs.**

- **Do not overload.** Ladder is intended for one person.
- **Make sure you are physically capable** to safely use the ladder. Strength, flexibility and stability are required.
- **Be aware that the vehicle may sway** as you climb the ladder. Do not use the ladder in high winds.
- **As you climb the ladder,** grasp the side rails firmly and always use both hands. Keep your body centered between the side rails. Do not over-reach.
- **Always store** the ladder extension when not in use.
- **Never allow children** on the ladder.
- **Do not transport items** anchored to the ladder. You could damage the ladder.

### **To Remove Ladder from Stored Position**

1. Unscrew ladder lock knob to remove.



Ladder Lock Knob

2. Lift ladder from storage rungs.

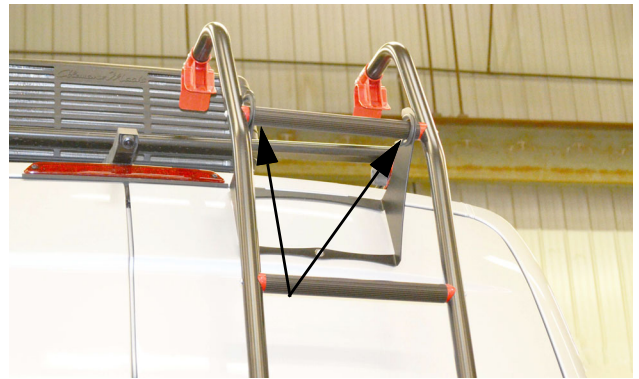

Ladder Storage Rungs

3. Mount ladder on driver side ladder roof rail. The ladder may be positioned at any point on the ladder roof rail.



Shown with Ladder properly mounted on rail at driver side rear

4. Reverse steps to store ladder.

## SECTION 9 – MISCELLANEOUS

---

---

---

### TIE-DOWN RINGS

#### –If Equipped

Your coach may be equipped with six (6) tie-down brackets (located in the rear of the coach) to give you the ability to restrain cargo while traveling.

#### To Install Tie-Down Ring into Floor Bracket

1. Push down on center of ring as shown in the following photo.



2. Slide tie-down ring into the floor bracket, then release the top of the tie down ring to secure into the floor bracket.



- Tie-down ring is now ready to restrain cargo. Repeat steps 1 and 2 for the remaining floor brackets needed to restrain your cargo.



- Reverse steps to remove tie-down ring from floor bracket.

The maximum weight capacity for the total of all cargo items to be secured by the floor tie-downs is 100 lbs.

It is the operator's responsibility to ensure that the cargo items are safely restrained using the available floor tie-downs before traveling.

---

---

### EFFECTS OF PROLONGED OCCUPANCY

Your motorhome was designed primarily for recreational use and short-term occupancy. If you expect to occupy your motorhome for an extended period, be prepared to deal with condensation and humid conditions that may be encountered.

#### Humidity and Condensation

Moisture condensing on the inside of windows is a visible indication that there is too much humidity inside the motorhome. Excessive moisture can cause water stains or mildew, which can damage interior items such as upholstery and cabinets.

When you recognize the signs of excessive moisture and condensation in your motorhome, you should take immediate action to minimize their effects.

You can help reduce excessive moisture inside the motorhome by taking the following steps:

**Ventilate with outside air**

Partially open one or more windows and a roof vent to circulate outside air through the motorhome. In cold weather, this ventilation may increase use of the furnace, but it will greatly reduce the condensation inside the motorhome.

**Minimize moisture released inside the motorhome**

Run the ceiling vent fan while cooking and open a bath vent while bathing or showering to carry water vapor out of the motorhome. Avoid making steam from boiling water excessively or letting hot water run. Avoid bringing extra moisture into the motorhome by way of soaked clothing or snow on shoes. Do not hang-dry wet overcoats or clothing inside the motorhome.



# INDEX

---

About this Manual .....	1-1
Air Conditioner Filter .....	4-5
Air Conditioner/Heater – Automotive (Dash) .....	3-3
Awning – Power with bluetooth .....	9-7
Bathroom .....	8-8
Before Driving .....	1-2
Cabinetry – Cleaning .....	8-6
Car or Trailer Towing .....	9-3
Carbon Monoxide Warning .....	2-3
Chassis Service and Maintenance .....	8-10
Child Restraints .....	3-2
Circuit Breakers – House 120-Volt AC .....	5-4
Circuit Breakers and Fuses – House 12-Volt DC .....	5-7
Combination Smoke/Carbon Monoxide Alarm .....	2-4
Cooktop (Electric) .....	4-1
Decorative Vinyl Wall Paneling – Cleaning .....	8-7
Diesel Exhaust Fluid Fill .....	3-4
Disinfecting Your Fresh Water System .....	6-3
Doors and Mirrors .....	8-9
Driving Safety .....	2-2
Ecoflow Battery and Chassis Battery Access .....	5-6
Effects of Prolonged Occupancy .....	9-10
Electrical .....	2-5
Electrical Cautions .....	5-1
Electrical Outlets – House 120-Volt AC .....	5-5
Emergency Exits .....	2-6
Engine Cooling System .....	3-3
Engine Overheat .....	2-9
Exterior Automotive Paint Finish .....	8-2
Exterior Graphic Care .....	8-4
Exterior Lights .....	8-5
Exterior Shower/Wash Station .....	6-5
Fire Extinguisher .....	2-5
Formaldehyde Information .....	2-7
Fresh Water System .....	6-1
Front Axle Tire Alignment .....	1-2
Fuel and Propane Gas .....	2-2
General Warnings .....	2-1
Ground Fault Circuit Interrupter .....	5-5
Hazard Warning Flashers .....	3-3
Headlight Alignment .....	1-2
Hydronic Heating System .....	4-5

---

# Index

---

Interior Soft Goods .....	8-5
Jump Starting .....	2-9
Keys .....	3-3
Ladder .....	9-8
Lights .....	3-4
Loading .....	2-5
Loading the Vehicle .....	9-1
Maintenance .....	2-5
Mold, Moisture, and Your Motorhome .....	2-7
Motorhome Maintenance Chart .....	8-12
Occupant and Cargo Carrying Capacity Label .....	1-3
OnePlace® Systems Monitor Panel .....	4-2
Owner and Vehicle Information .....	1-6
Plastic Parts – Cleaning .....	8-5
Power Cord – External (Detachable) .....	5-3
Power Loft Bed .....	7-1
Power Roof Ventilator .....	9-6
Power Roof Ventilator (Bath) .....	9-6
Power Sofas and Beds .....	2-7
Pre-Delivery Inspection .....	1-2
Radio – In-Dash .....	3-3
Range and Refrigerator .....	8-7
Refrigerator .....	4-1
Remote Keyless Entry .....	3-3
Reporting Safety Defects .....	1-3
Roadside Emergency .....	2-8
Roof .....	8-1
Roof Air Conditioning System WITH BLUETOOTH CONTROL .....	4-4
Safety Messages Used in this Manual .....	1-1
Sealants – Inspection and General Information .....	8-1
Seat Belts .....	3-1
Seats – Driver/Co-Pilot .....	3-1
Service and Assistance .....	1-2
Shower Hose Vacuum Breaker .....	6-5
Sink – Stainless Steel .....	8-7
Sleeping Facilities .....	7-1
Sliding door Screen Zipper Enclosure .....	7-4
Solar Charge Panel .....	4-3
Specifications and Capacities .....	1-5
Suspension Alignment and Tire Balance .....	3-4
Table (Exterior) .....	7-1
Tables and Countertops .....	8-7
Tie-Down Rings .....	9-10
Tires .....	3-4
Toilet .....	6-6

---

---

Towing Guidelines .....	9-4
Trailer Wiring Connector .....	9-4
Undercarriage .....	8-1
Vehicle Certification Label .....	1-4
Vehicle Storage – Preparation .....	8-9
Vehicle Storage – Removal .....	8-10
Vinyl Flooring .....	8-7
Waste Water System – Waste Pump .....	6-7
Water Pump .....	6-2
Water System Drain Locations .....	6-15
Waterline and Tank Drain Valves .....	6-8
Weighing Your Loaded Vehicle .....	9-1
Wheels .....	2-9
Window Shades/Screens .....	7-4
Windows .....	8-8
Windows .....	9-5
Winnebago x EcoFlow Power Kit Pro Monitor Panel .....	5-1
Winterizing Procedure .....	6-9

---

